

Invitation for Bid

The Rochester Housing Authority, Rochester, New York, will receive sealed bids for **Danforth Towers Façade Repairs- Ph II**

in connection with the **Above Project** Project, NY-41-02B/B1 at **140 West Ave, Rochester, New York**, until:

May 10, 2024 @ 11:00 a.m. at its Procurement Office, 495 Upper Falls Blvd., Rochester, New York, at which time and place all bids will be publicly opened and read aloud.

There will be a walk through at 140 West Ave. on April 18, 2024 at 11:00 am.

All questions for this solicitation must be received in writing before 3 PM, April 25, 2024. All questions will be answered in a written summary or addendum.

The bid package may be obtained from the Avalon Website at www.avalonroch-planroom.com. and at www.rochesterhousing.org/bid-opportunities request beginning **April 10, 2024.**

Bids will not be accepted unless the documents have been obtained under the name of the bidding party and all other bid requirements, as identified here, are met. Bids must include all required documentation, bid security and addendum(s).

The contact person (s) is/are **David Stier dstier@rochesterhousing.org**

A certified check or bank draft, payable to the Rochester Housing Authority or a satisfactory Bid Bond executed by the Bidder and an acceptable surety company listed on US Treasury Circular 570, in an amount equal to five percent (5%) of the bid shall be submitted with each bid more than One Hundred Fifty Thousand Dollars (\$150,000).

For all construction contracts exceeding \$150,000, the successful bidder shall be required to furnish and pay for a Performance Bond & a Payment Bond each for 100% of the contract price (Surety company must be listed on the US Treasury Circular 570 as a certified company), or an Irrevocable Letter of Credit covering 25% of the work, or a 20% cash escrow of the contract price.

The Rochester Housing Authority reserves the right to reject any or all bids for any reason or to waive any informalities in the bidding.

No bids shall be withdrawn for a period of ninety (90) days after bid opening. without the express consent of the Rochester Housing Authority.

Rochester Housing Authority



To: All Contractors

All bids that are submitted to RHA must include completely filled out bid forms.

What does this consist of?

- a. Bid Proposal form must be completed with any unit prices and alternates
- b. Schedule of Amounts for Contract Payments (HUD-51000)
- c. Previous Participation Certification (HUD-2530) for jobs over \$50,000.00-completed
- d. Acknowledgment of Principal – **Notarized**
- e. Affidavit - **Notarized**
- f. Representations, Certifications, and Other Statements of Bidders (HUD-5369A) must be fully filled out completely
- g. Completed Acknowledgment of HUD and RHA General Rules and Regulations Packet- **Notarized**- This packet includes Policy regarding Three Contract Limit, (HUD-5369, 5370, or 5370 EZ), Schedule of Liquidated Damages. These reside on our website www.rochesterhousing.org
- h. 5% Bid Security for all bids over \$150,000
- i. If Applicable, Acknowledgment of receipt of Addendum(s). Signed cover page(s) of all addendum(s) pertaining to this project **must** be included with bid submission.
- h. Section 3 Vendor Commitment form. **MUST be included in your bid submission.**

(Note: All Notary stamps/signatures MUST be originals, not photocopies)

Failure to include the above items in your bid may render the bid non-responsive.

If you have any questions on the above paperwork or require any clarification, please contact dstier@rochesterhousing.org

PROPOSAL FORM
Danforth Towers Façade Repairs- Ph II

PROJECT NY 41-02B/B1

Date: May 10, 2024

Rochester Housing Authority
495 Upper Falls Blvd., deliver to side entrance/Procurement
Rochester, New York 14605

Contractors:

The undersigned, having become familiar with the Contract Documents including all addenda (No's _____), the requirements necessary to provide, perform and/or supply as necessary the work, materials, supplies or equipment as either solicited or advertised and further having visited the site of the project to ascertain all local conditions affecting the cost of the work, material, supplies or equipment, hereby proposes to furnish all the labor, materials, tools, supplies, equipment and all other incidental items necessary to complete the work or deliver in first class condition supplies and/or equipment, including insurance and taxes, and to do and perform all things as required in the specifications, all in accordance with the Contract Documents, TERMS MAY BE UPDATED FROM TIME TO TIME, WHICH TERMS ARE INCORPORATED HEREIN BY REFERENCE AND MADE PART HEREOF, for the total sum of;

_____ and /100 dollars

(\$ _____)

If unit prices are noted for additional work or work that may be required in conjunction with this contract the unit prices will then become part of this proposal.

Unit Prices

\$ NOT APPLICABLE

DEDUCT Alternates

\$ NOT APPLICABLE

The undersigned further agrees to complete the entire work to the satisfaction of the Rochester Housing Authority, and in strict conformance with the Drawings, Specifications, and the Contract Documents within **90** calendar days after the date upon which work hereunder is to commence as set forth in the Notice and Order to Proceed, and that Liquidated Damages may be assessed by the Authority as per the "Schedule of Liquidated Damages" for each calendar day of delay beyond the completion date as established in the Notice and Order to Proceed. The Notice and Order to Proceed will commence on the day of the Pre-Construction Conference, and/or Purchase Order is given to the Contractor/unless a specific date is in the Special Conditions in the bid package.

(Bidder)

(Address)

(City State Zip)

(Signature & Title)

**Schedule of Amounts for
Contract Payments**

**U.S. Department of Housing and Urban
Development
Office of Public and Indian Housing**

OMB Approval No. 2577-0157
(Exp. 11/30/2023)

	A	B	C	D	E	F	G	H	I
1	No progress payments shall be made to the contractor unless a schedule of amounts for contract payments in accordance with the construction contract is received.								
2	Public reporting burden for the collection of this information is estimated to average 1 hour per response, including the time for reviewing instructions, searching existing data sources, gathering and maintaining the data needed, and completing and reviewing the collection of information. The agency may not conduct or sponsor, and a person is not required to respond to, a collection of information unless the collection displays a valid OMB control number. Construction practices and HUD administrative requirements establish the need that HA's maintain certain records or submit certain documents in conjunction with the oversight of the award of construction contracts for the construction of new low-income housing developments or modernization of existing developments. These forms are used by HAs to provide information on the construction progress schedule of amounts for contract payments. Responses to the collection of information are required to obtain a benefit or to retain a benefit. The information requested does not lend itself to confidentiality.								
3	Project Name & Location:		Danforth Towers Façade Repairs-Ph II						
4	Name, Address, and Zip						Project Number	41-02B & 02B1	
5	Code of Contractor						Contract Number		
6	Nature of Contract:		Façade Repairs						
7	Approved for Contractor by					Title:		Date:	
8	Approved for Architect by					Title:		Date:	
9	Approved by Owner by					Title:		Date:	
10	Item No	Description of Item	Quantity	Unit of Measure	Unit Price in Place	Amount of Sub-Item	Amount of Principal		
11	(1)	(2)	(3)	(4)	(5)	(6)	(7)		
12	1	Bond	1	lump sum	\$0.00	\$0.00	\$0.00		
13	2	General Conditions (5%maximum)	1	lump sum	\$0.00	\$0.00	\$0.00		
14	11	Waterproofing & Dampproofing					\$0.00		
15		sub-item	Labor	0.00	hours	\$0.00	\$0.00		
16		sub-item	Materials	1	each	\$0.00	\$0.00		
17	14	Masonry					\$0.00		
18		sub-item	Labor	0.00	hours	\$0.00	\$0.00		
19		sub-item	Materials	1	each	\$0.00	\$0.00		
20	22	Caulking					\$0.00		
21		sub-item	Labor	0.00	hours	\$0.00	\$0.00		
22		sub-item	Materials	1	each	\$0.00	\$0.00		
23	42	(Other) Cleaning of Masonry					\$0.00		
24		sub-item	Labor	0.00	hours	\$0.00	\$0.00		
25		sub-item	Materials	1	each	\$0.00	\$0.00		
26	63	Punch List (2)					\$0.00		
27		sub-item	Labor	1	hours	\$0.00	\$0.00		
28		sub-item	Materials	1	each	\$0.00	\$0.00		
29	64	Lawns & Plantings					\$0.00		
30		sub-item	Labor	0.00	hours	\$0.00	\$0.00		
31		sub-item	Materials	1	each	\$0.00	\$0.00		
32	62	Other					\$0.00		
33		sub-item	Labor	0.00	hours	\$0.00	\$0.00		
34		sub-item	Materials	1	each	\$0.00	\$0.00		
35		Permits					\$0.00		
36		Overhead					\$0.00		
37		Profit					\$0.00		
38	Total Amount of Contract or Carried Forward							\$0.00	

**Schedule of Amounts for
Contract Payments**

**U.S. Department of Housing and Urban
Development
Office of Public and Indian Housing**

OMB Approval No. 2577-0157
(Exp. 11/30/2023)

	A	B	C	D	E	F	G	H	I
38	To the best of my knowledge, all the information stated herein, as well as any information provided in the accompaniment herewith, is true and accurate. Warning: HUD will prosecute false claims and statements. Conviction may result in criminal and/or civil penalties. (18 U.S.C. 1001, 1010, 1012; 31 U.S.C. 3729, 3802)								
39	Signature of authorized representative							Date signed (mm/dd/yyyy)	
40	X								
41								form HUD-51000 (7/97)	
42	Previous editions are obsolete							ref Handbooks 7417.1 and 7485.1	

**Schedule of Amounts for
Contract Payments**

**U.S. Department of Housing and Urban
Development
Office of Public and Indian Housing**

OMB Approval No. 2577-0157
(Exp. 11/30/2023)

No progress payments shall be made to the contractor unless a schedule of amounts for contract payments in accordance with the construction contract is received.

Public reporting burden for the collection of this information is estimated to average 1 hour per response, including the time for reviewing instructions, searching existing data sources, gathering and maintaining the data needed, and completing and reviewing the collection of information. The agency may not conduct or sponsor, and a person is not required to respond to, a collection of information unless the collection displays a valid OMB control number. Construction practices and HUD administrative requirements establish the need that HA's maintain certain records or submit certain documents in conjunction with the oversight of the award of construction contracts for the construction of new low-income housing developments or modernization of existing developments. These forms are used by HAs to provide information on the construction progress schedule of amounts for contract payments. Responses to the collection of information are required to obtain a benefit or to retain a benefit. The information requested does not lend itself to confidentiality.

Project Name & Location:		Example Project						
Name, Address, and Zip Code of Contractor						Project Number	xxxxx	
Nature of Contract:		Example Project				Contract Number	xxxxx	
Approved for Contractor by				Title:		Date		
Approved for Architect by				Title:		Date		
Approved by Owner by				Title:		Date		
Item No (1)	Description of Item (2)	Quantity (3)	Unit of Measure (4)	Unit Price in Place (5)	Amount of Sub-Item (6)	Amount of Principal (7)		
2	General Conditions (5%maximum)	1	lump sum	10.00	10.00	10.00		
3	Demo & Clearing						450.00	
	sub-item	Labor	10.00	hours	35.00	350.00		
	sub-item	Materials	1	each	100.00	100.00		
14	Masonry						450.00	
	sub-item	Labor	10.00	hours	35.00	350.00		
	sub-item	Materials	1	each	100.00	100.00		
19	Sheet Metal						450.00	
	sub-item	Labor	10.00	hours	35.00	350.00		
	sub-item	Materials	1	each	100.00	100.00		
22	Caulking						450.00	
	sub-item	Labor	10.00	hours	35.00	350.00		
	sub-item	Materials	1	each	100.00	100.00		
24	Lath & Plastering - Drywall						450.00	
	sub-item	Labor	10.00	hours	35.00	350.00		
	sub-item	Materials	1	each	100.00	100.00		
26	Finish Carpentry						450.00	
	sub-item	Labor	10.00	hours	35.00	350.00		
	sub-item	Materials	1	each	100.00	100.00		
32	Floors						450.00	
	sub-item	Labor	10.00	hours	35.00	350.00		
	sub-item	Materials	1	each	100.00	100.00		
33	Painting & Decorating						450.00	
	sub-item	Labor	10.00	hours	35.00	350.00		
	sub-item	Materials	1	each	100.00	100.00		
35	Plumbing						450.00	
	sub-item	Labor	10.00	hours	35.00	350.00		

**Schedule of Amounts for
Contract Payments**

**U.S. Department of Housing and Urban
Development
Office of Public and Indian Housing**

OMB Approval No. 2577-0157
(Exp. 11/30/2023)

	sub-item	Materials	1	each	100.00	100.00	
37	Ventilating System						450.00
	sub-item	Labor	10.00	hours	35.00	350.00	
	sub-item	Materials	1	each	100.00	100.00	
38	Electrical						450.00
	sub-item	Labor	10.00	hours	35.00	350.00	
	sub-item	Materials	1	each	100.00	100.00	
43	Other						450.00
	sub-item	Labor	10	hours	35.00	350.00	
	sub-item	Materials	1	each	100.00	100.00	
57	Shades & Drapery Rods						450.00
	sub-item	Labor	10	hours	35.00	350.00	
	sub-item	Materials	1	each	100.00	100.00	
60	Kitchen Cabinets						450.00
	sub-item	Labor	10	hours	35.00	350.00	
	sub-item	Materials	1	each	100.00	100.00	
63	Punch List						450.00
		Labor	10	hours	35.00	350.00	
		Materials	1	each	100.00	100.00	
	Permits						10.00
	Overhead						10.00
	Profit						10.00
	Total Amount of Contract or Carried Forward						\$6,760.00

To the best of my knowledge, all the information stated herein, as well as any information provided in the accompaniment herewith, is true and accurate. Warning: HUD will prosecute false claims and statements. Conviction may result in criminal and/or civil penalties. (18 U.S.C. 1001, 1010, 1012; 31 U.S.C. 3729, 3802)

Signature of authorized representative

Date signed (mm/dd/yyyy)

X

form HUD-51000 (7/97)

Previous editions are obsolete

ref Handbooks 7417.1 and 7485.1

Master List of Items

Item NO. Division of Work

- 1 Bond
- 2 General Conditions (1)
- 3 Demolition & Clearing

Structures

- 4 General Excavation

Item NO. Division of Work

- 20 Rough Carpentry
- 21 Metal Bucks
- 22 Caulking
- 23 Weatherstripping
- 24 Lath & Plaster-Drywall

- 25 Stucco

Site Improvements

- Retaining Walls
- Storm Sewers
- Sanitary Sewers
- Water Distribution System

**Schedule of Amounts for
Contract Payments**

**U.S. Department of Housing and Urban
Development
Office of Public and Indian Housing**

OMB Approval No. 2577-0157
(Exp. 11/30/2023)

5	Footing Excavation	26	Finish Carpentry	Gas Distribution System
6	Backfill	27	Finish Hardware	Electrical Distribution System
7	Foundation Piles & Caissons	28	Glass & Glazing	Street & Yard lighting
8	Concrete Foundations	29	Metal Doors	Fire & Police Alarm System
9	Concrete Superstructures	30	Metal Base & Trim	Fire Protection System
10	Reinforced Steel	31	Toilet Partitions	Street Work
11	Waterproofing & Dampproofing	32	Floors	Yard Work
12	Spandrel Waterproofing	33	Painting & Decorating	(Other)
13	Structural Steel	34	Screens	(Other)
14	Masonry	35	Plumbing	
15	Stonework	36	Heating	
16	Miscellaneous & Ornamental Metal	37	Ventilating System	Equipment
17	Metal Windows	38	Electrical	Shade & Drapery Rods
18	Roofing	39	Elevators	Ranges
19	Sheet Metal	40	Elevator Enclosures-Metal	Refrigerators
				Kitchen Cabinets & Work
		41	Incinerators-Masonry & Parts	Tables
		42	(Other)	Laundry Equipment
		43	(Other)	(Other)
				Punch List (2)
				Lawns & Plantings
1	General Conditions should be 3% to 5% of contract amount.			
2	Punch List should be approximately 1/2 of 1% or \$30.00 per dwelling unit whichever is greater.			

Previous editions are obsolete

form HUD-51000 (4/20)
ref Capital Fund Guidebook

US Department of Housing and Urban Development
Office of Housing/Federal Housing Commissioner

US Department of Agriculture
Farmers Home Administration

Part I to be completed by Principals of Multifamily Projects (See instructions)		For HUD HQ/FmHA use only	
Reason for submission:			
1. Agency name and City where the application is filed		2. Project Name, Project Number, City and Zip Code	
3. Loan or Contract amount \$	4. Number of Units or Beds	5. Section of Act	6. Type of Project (check one) <input type="checkbox"/> Existing <input type="checkbox"/> Rehabilitation <input type="checkbox"/> Proposed (New)

7. List all proposed Principals and attach organization chart for all organizations

Name and address of Principals and Affiliates (Name: Last, First, Middle Initial) proposing to participate	8 Role of Each Principal in Project	9. SSN or IRS Employer Number

Certifications: The principal(s) listed above hereby apply to HUD or USDA FmHA, as the case maybe, for approval to participate as principal(s) in the role(s) and project listed above. The principal(s) each certify that all the statements made on this form are true, complete and correct to the best of their knowledge and belief and are made in good faith, including any Exhibits attached to this form. **Warning:** HUD will prosecute false claims and statements. Conviction may result in criminal and/or civil penalties. The principal(s) further certify that to the best of their knowledge and belief:

1. Schedule A contains a listing, for the last ten years, of every project assisted or insured by HUD, USDA FmHA and/or State and local government housing finance agencies in which the principal(s) have participated or are now participating.
2. For the period beginning 10 years prior to the date of this certification, and except as shown on the certification:
 - a. No mortgage on a project listed has ever been in default, assigned to the Government or foreclosed, nor has it received mortgage relief from the mortgagee;
 - b. The principals have no defaults or noncompliance under any Conventional Contract or Turnkey Contract of Sale in connection with a public housing project;
 - c. There are no known unresolved findings as a result of HUD audits, management reviews or other Governmental investigations concerning the principals or their projects;
 - d. There has not been a suspension or termination of payments under any HUD assistance contract due to the principal's fault or negligence;
 - e. The principals have not been convicted of a felony and are not presently the subject of a complaint or indictment charging a felony. (A felony is defined as any offense punishable by imprisonment for a term exceeding one year, but does not include any offense classified as a misdemeanor under the laws of a State and punishable by imprisonment of two years or less);
 - f. The principals have not been suspended, debarred or otherwise restricted by any Department or Agency of the Federal Government or of a State Government from doing business with such Department or Agency;
 - g. The principals have not defaulted on an obligation covered by a surety or performance bond and have not been the subject of a claim under an employee fidelity bond;
3. All the names of the principals who propose to participate in this project are listed above.
4. None of the principals is a HUD/FmHA employee or a member of a HUD/FmHA employee's immediate household as defined in Standards of Ethical Conduct for Employees of the Executive Branch in 5 C.F.R. Part 2635 (57 FR 35006) and HUD's Standard of Conduct in 24 C.F.R. Part 0 and USDA's Standard of Conduct in 7 C.F.R. Part 0 Subpart B.
5. None of the principals is a participant in an assisted or insured project as of this date on which construction has stopped for a period in excess of 20 days or which has been substantially completed for more than 90 days and documents for closing, including final cost certification, have not been filed with HUD or FmHA.
6. None of the principals have been found by HUD or FmHA to be in noncompliance with any applicable fair housing and civil rights requirements in 24 CFR 5.105(a). (If any principals or affiliates have been found to be in noncompliance with any requirements, attach a signed statement explaining the relevant facts, circumstances, and resolution, if any).
7. None of the principals is a Member of Congress or a Resident Commissioner nor otherwise prohibited or limited by law from contracting with the Government of the United States of America.
8. Statements above (if any) to which the principal(s) cannot certify have been deleted by striking through the words with a pen, and the relevant principal(s) have initialed each deletion (if any) and have attached a true and accurate signed statement (if applicable) to explain the facts and circumstances.

Name of Principal	Signature of Principal	Certification Date(mm/dd/yyyy)	Area Code and Tel. No.
This form prepared by (print name)			Area Code and Tel. No.

Previous Participation Certification

OMB Approval No. 2502-0118
(Exp. 05/31/2019)

Schedule A: List of Previous Projects and Section 8 Contracts. Below is a complete list of the principals' previous participation projects and participation history in multifamily Housing programs of HUD/FmHA, State and local Housing Finance Agencies. **Note:** Read and follow the instruction sheet carefully. Make full disclosure. Add extra sheets if you need more space. Double check for accuracy. If no previous projects, write by your name, **"No previous participation, First Experience"**.

1. Principals Name (Last, First)	2. List of previous projects (Project name, project ID and, Govt. agency involved)	3. List Principals' Role(s) (indicate dates participated, and if fee or identity of interest participant)	4. Status of loan (current, defaulted, assigned, foreclosed)	5. Was the Project ever in default during your participation Yes No If yes, explain		6. Last MOR rating and Physical Insp. Score and date

Part II- For HUD Internal Processing Only

Received and checked by me for accuracy and completeness; recommend approval or refer to Headquarters after checking appropriate box.

Date (mm/dd/yyyy)	Tel No. and area code	<input type="checkbox"/> A. No adverse information; form HUD-2530 approval recommended. <input type="checkbox"/> B. Name match in system <input type="checkbox"/> C. Disclosure or Certification problem <input type="checkbox"/> D. Other (attach memorandum)	
Staff	Processing and Control		
Supervisor	Director of Housing/Director, Multifamily Division	Approved <input type="checkbox"/> Yes <input type="checkbox"/> No	Date (mm/dd/yyyy)

Instructions for Completing the Previous Participation Certificate, form HUD-2530

Carefully read these instructions and the applicable regulations. A copy of those regulations published at 24 C.F.R. 200.210 to 200.245 can be obtained from the Multifamily Housing Representative at any HUD Office. Type or print neatly in ink when filling out this form. Mark answers in all blocks of the form. If the form is not filled completely, it will delay approval of your application.

Attach extra sheets as you need them. Be sure to indicate "Continued on Attachments" wherever appropriate. Sign each additional page that you attach if it refers to you or your record.

Carefully read the certification before you sign it. Any questions regarding the form or how to complete it can be answered by your HUD Office Multifamily Housing Representative.

Purpose: This form provides HUD with a certified report of all previous participation in HUD multifamily housing projects by those parties making application. The information requested in this form is used by HUD to determine if you meet the standards established to ensure that all principal participants in HUD projects will honor their legal, financial and contractual obligations and are acceptable risks from the underwriting standpoint of an insurer, lender or governmental agency. HUD requires that you certify your record of previous participation in HUD/USDA-FmHA, State and Local Housing Finance Agency projects by completing and signing this form, before your project application or participation can be approved.

HUD approval of your certification is a necessary precondition for your participation in the project and in the capacity that you propose. If you do not file this certification, do not furnish the information requested accurately, or do not meet established standards, HUD will not approve your certification.

Note that approval of your certification does not obligate HUD to approve your project application, and it does not satisfy all other HUD program requirements relative to your qualifications.

Who Must Sign and File Form HUD-2530:

Form HUD-2530 must be completed and signed by all principals applying to participate in HUD multifamily housing projects, including those who have no previous participation. The form must be signed and filed by all principals and their affiliates who propose participating in the HUD project. Use a separate form for each role in the project unless there is an identity of interest.

Principals include all individuals, joint ventures,

partnerships, corporations, trusts, non-profit organizations, any other public or private entity that will participate in the proposed project as a sponsor, owner, prime contractor, turnkey developer, managing agent, nursing home administrator or operator, packager, or consultant. Architects and attorneys who have any interest in the project other than an arm's length fee arrangement for professional services are also considered principals by HUD.

In the case of partnerships, all general partners regardless of their percentage interest and limited partners having a 25 percent or more interest in the partnership are considered principals. In the case of public or private corporations or governmental entities, principals include the president, vice president, secretary, treasurer and all other executive officers who are directly responsible to the board of directors, or any equivalent governing body, as well as all directors and each stockholder having a 10 percent or more interest in the corporation.

Affiliates are defined as any person or business concern that directly or indirectly controls the policy of a principal or has the power to do so. A holding or parent corporation would be an example of an affiliate if one of its subsidiaries is a principal.

Exception for Corporations – All principals and affiliates must personally sign the certificate except in the following situation. When a corporation is a principal, all of its officers, directors, trustees and stockholders with 10 percent or more of the common (voting) stock need not sign personally if they all have the same record to report. The officer who is authorized to sign for the corporation or agency will list the names and title of those who elect not to sign. However, any person who has a record of participation in HUD projects that is separate from that of his or her organization must report that activity on this form and sign his or her name. The objective is full disclosure.

Exemptions – The names of the following parties do not need to be listed on form HUD-2530: Public Housing Agencies, tenants, owners of less than five condominium or cooperative units and all others whose interests were acquired by inheritance or court order.

Where and When Form HUD-2530 Must Be Filed:

The original of this form must be submitted to the HUD Office where your project application will be processed at the same time you file your initial project application. This form must be filed with applications for projects, or when otherwise required in the situations listed below:

- Projects to be financed with mortgages insured under the National Housing Act (FHA).
- Projects to be financed according to Section 202 of the Housing Act of 1959 (Elderly and

Handicapped).

- Projects in which 20 percent or more of the units are to receive a subsidy as described in 24 C.F.R. 200.213.
- Purchase of a project subject to a mortgage insured or held by the Secretary of HUD.
- Purchase of a Secretary-owned project.
- Proposed substitution or addition of a principal or principal participation in a different capacity from that previously approved for the same project.
- Proposed acquisition by an existing limited partner of an additional interest in a project resulting in a total interest of 25 percent or more or proposed acquisition by a corporate stockholder of an additional interest in a project resulting in a total interest of 10 percent or more.
- Projects with U.S.D.A., Farmers Home Administration, or with state or local government housing finance agencies that include rental assistance under Section 8 of the Housing Act of 1937. For projects of this type, form HUD-2530 should be filed with the appropriate applications directly to those agencies.

Review of Adverse Determination: If approval of your participation in a HUD project is denied, withheld, or conditionally granted on the basis of your record of previous participation, you will be notified by the HUD Office. You may request reconsideration by the HUD Review Committee. Alternatively, you may request a hearing before a Hearing Officer. Either request must be made in writing within 30 days from your receipt of the notice of determination.

If you do request reconsideration by the Review Committee and the reconsideration results in an adverse determination, you may then request a hearing before a Hearing Officer. The Hearing Officer will issue a report to the Review Committee. You will be notified of the final ruling by certified mail.

Specific Line Instructions:

Reason for submitting this Certification: e.g., refinance, change in ownership, change in management agent, transfer of physical assets, etc.

Block 1: Fill in the name of the agency to which you are applying. For example: HUD Office, Farmers Home Administration District office, or the name of a State or local housing finance agency. Below that, fill in the name of the city where the office is located.

Block 2: Fill in the name of the project, such as "Greenwood Apts." If the name has not yet been selected, write "Name unknown." Below that, enter the HUD contract or project identification number, the Farmers Home Administration project number, or the State or local housing finance agency project or contract number. Include **all** project or contract

identification numbers that are relevant to the project. Also enter the name of the city in which the project is located, and the ZIP Code.

Block 3: Fill in the dollar amount requested in the proposed mortgage, or the annual amount of rental assistance requested.

Block 4: Fill in the number of apartment units proposed, such as "40 units." For hospital projects or nursing homes, fill in the number of beds proposed, such as "100 beds."

Block 5: Fill in the section of the Housing Act under which the application is filed.

Block 7: Definitions of all those who are considered principals and affiliates are given above in the section titled "Who Must Sign and File...."

Block 8: Beside the name of each principal, fill in the appropriate role. The following are examples of possible roles that the principals may assume: Owner/Mortgagor, Managing Agent, Sponsor, Developer, General Con-tractor, Packager, Consultant, Nursing Home Administrator etc.

Block 9: Fill in the Social Security Number or IRS employer number of every principal listed, including affiliates.

Instructions for Completing Schedule A:

Be sure that Schedule A is filled-in completely, accurately and the certification is properly dated and signed, because it will serve as a legal record of your previous experience. All Multifamily Housing projects involving HUD/ FmHA, and State and local Housing Finance Agencies in which you have previously participated **must be** listed. Applicants are reminded that previous participation pertains to the individual principal within an entity as well as the entity itself. A newly formed company may not have previous participation, but the principals within the company may have had extensive participation and disclosure of that activity is required.

Column 2. All previous projects must be listed or your certification cannot be processed. Include the name of all projects, project number, city where it is located and the governmental agency (HUD, USDA-FmHA or state or local housing finance agency) that was involved.

Column 3. List the role(s) as a principal, dates participated and if fee or identity of interest (IOI) with owners.

Column 4. Indicate the current status of the loan. Except for current loan, the date associated with the status is required. Loans under a workout arrangement are considered assigned. For all noncurrent loans, an explanation of the status is required.

Column 5. Explain any project defaults during your participation.

Column 6. Provide the latest Management Review (MOR) rating and Physical Inspection score.

Certification: After you have completed all other parts of

form HUD-2530, including schedule A, read the Certification carefully. In the box below the statement of the certification, fill in the names of all principals and affiliates as listed in block 7. Each principal should sign the certification with the exception in some cases of individuals associated with a corporation (see "Exception for Corporations" in the section of the instructions titled "Who Must Sign and File Form HUD-2530). Principal who is signing on behalf of the entity should attach signature authority document. Each principal who signs the form should fill in the date of the signature and

a telephone number. By providing a telephone number, HUD can reach you in the event of any questions.

If you cannot certify and sign the certification as it is printed because some statements do not correctly describe your record, use a pen to strike through those parts that differ with your record, and then sign and certify.

Attach a signed statement of explanation of the items you have struck out on the certification. Item 2e. relates to felony convictions within the past 10 years. If you are convicted of

a felony within the past 10 years, strike out 2e. and attach statement of explanation. A felony conviction will not necessarily cause your participation to be disapproved unless there is a criminal record or other evidence that your previous conduct or method of doing business has been such that your participation in the project would make it an unacceptable risk from the underwriting stand point of an insurer, lender or governmental agency.

The Department of Housing and Urban Development (HUD) is authorized to collect this information by law (42 U.S.C. 3535(d) and 24 C.F.R. 200.217) and by regulation at 24 CFR 200.210. This information is needed so that principals applying to participate in multifamily programs can become HUD-approved participants. The information you provide will enable HUD to evaluate your record with respect to established standards of performance, responsibility and eligibility. Without prior approval, a principal may not participate in a proposed or existing multifamily project. HUD uses this information to evaluate whether or not principals pose an unsatisfactory underwriting risk. The information is used to evaluate the potential principals and approve only individuals and organizations that will honor their legal, financial and contractual obligations.

Privacy Act Statement: The Housing and Community Development Act of 1987, 42 U.S.C. 3543 requires persons applying for a Federally-insured or guaranteed loan to furnish his/her Social Security Number (SSN). HUD must have your SSN for identification of your records. HUD may use your SSN for automated processing of your records and to make requests for information about you and your previous records with other public agencies and private sector sources. HUD may disclose certain information to Federal, State and local agencies when relevant to civil, criminal, or regulatory investigations and prosecutions. It will not be otherwise disclosed or released outside of HUD, except as required and permitted by law. You must provide all of the information requested in this application, including your SSN.

Public reporting burden for this collection of information is estimated to average 1 hour per response, including the time for reviewing instructions, searching existing data sources, gathering and maintaining the data needed, and completing and reviewing the collection of information. This agency may not collect this information, and you are not required to complete this form, unless it displays a currently valid OMB control number.

A response is mandatory. Failure to provide any of the information will result in your disapproval of participation in this HUD program.

If the business owned by the individual or partnership is conducted under a trade or assumed name, a certified copy of doing business under an assumed name should be annexed.

Acknowledgment of Principal, if a Corporation

State of _____) S.S.
County of _____)
On this _____ day of _____ 20____ before me personally appeared _____
_____ To me known, who, being by me duly sworn, did depose and say that he/she
resides at _____, that he/she is the _____
of _____ The corporation described in and which executed the foregoing
instrument; that he/she knows the seal of said corporation; that one of the seals affixed to said instrument is
such seal; that it was so affixed by order of the director of said corporation and that he/she signed his name
thereto by like order.

Signature of Principal

Notary Public

Acknowledgment of Principal, if a Partnership

State of _____) S.S.
County of _____)
On this _____ day of _____ 20____ before me personally appeared _____
_____ To me known and known to me to be one of the members of the firm of
_____, described in and who executed the foregoing instrument and
he/she acknowledged to me that he/she executed the same as and for the act of said firm.

Signature of Partner

Notary Public

Acknowledgment of Principal, if an Individual

State of _____) S.S.
County of _____)
On this _____ day of _____ 20____ before me personally appeared _____
_____ To me known and known to me to be the person described in and who executed
the foregoing instrument and acknowledged the same.

Signature of Owner

Notary Public

If bidder is a firm, state here the name and residence of each member thereof.

Name of Partners

Residence Address

Affidavit of Non-Collusion

State of _____)
County of _____) S.S.
City of _____)

_____ Being first duly sworn deposes and says: that he/she is _____
(Printed Name) (Title)

of _____ the party making the foregoing proposal or bid, that such bid is
(Company Name)
genuine and not collusive or sham that said bidder has not colluded, conspired, connived, or agreed directly or indirectly, with any bid, bidder, or person, to put in a sham bid or to refrain from bidding, and has not in any manner, directly, or indirectly, sought by agreement or collusion, or communication or conference with any person to fix the bid price of afficant or any other bidder, or to fix any overhead, profit, or cost element of said bid price, or of that of any bidder or to secure any advantage against the Rochester Housing Authority or any person interested in the proposed contract and that all statements contained in said proposal or bid are true.

Each bidder that contacts the Rochester Housing Authority (RHA) during the restricted period of a proposal or bid shall only make contact with the individuals stated in the bidding paperwork provided by RHA or contact those referred to by an individual stated in the RHA bidding paperwork. Contact to any other employee, officer, or member of the RHA regarding a bid or proposal during the restricted period is in violation of New York State – State Finance Laws Section 139-j and 139-k. The “restricted period” of a bidding opportunity is the period of time commencing with the earliest written notice or advertisement and ending with the final contract award written notification provided by RHA. By signing this affidavit the bidder understands of and agrees to comply with the RHA's procedures relating to permissible contacts during a governmental procurement pursuant to New York State Finance Laws Section 139-j and 139-k, that all information provided to the RHA with respect to these sections is complete, true, and accurate. In the event such certification is found to be intentionally false, intentionally incomplete, or does not disclose the determination of being non-responsible by any other governmental entity for violating similar regulations over the previous four years then the RHA reserves the right to terminate any contracts awarded to such bidder.

Signature of Bidder

Date

Subscribed and sworn to this _____ day of _____, 20_____.

Notary Public

If oath is taken outside of New York State, a County Clerk's Certificate as to the authority of the officer administering the oath must be attached.

**U.S. Department of Housing and
Urban Development**
Office of Public and Indian Housing

**Instructions to Bidders for Contracts
Public and Indian Housing Programs**

Instructions to Bidders for Contracts

Public and Indian Housing Programs

Table of Contents

Clause	Page
1. Bid Preparation and Submission	1
2. Explanations and Interpretations to Prospective Bidders	1
3. Amendments to Invitations for Bids	1
4. Responsibility of Prospective Contractor	1
5. Late Submissions, Modifications, and Withdrawal of Bids	1
6. Bid Opening	2
7. Service of Protest	2
8. Contract Award	2
9. Bid Guarantee	3
10. Assurance of Completion	3
11. Preconstruction Conference	3
12. Indian Preference Requirements	3

1. Bid Preparation and Submission

(a) Bidders are expected to examine the specifications, drawings, all instructions, and, if applicable, the construction site (see also the contract clause entitled **Site Investigation and Conditions Affecting the Work** of the *General Conditions of the Contract for Construction*). Failure to do so will be at the bidders' risk.

(b) All bids must be submitted on the forms provided by the Public Housing Agency/Indian Housing Authority (PHA/IHA). Bidders shall furnish all the information required by the solicitation. Bids must be signed and the bidder's name typed or printed on the bid sheet and each continuation sheet which requires the entry of information by the bidder. Erasures or other changes must be initialed by the person signing the bid. Bids signed by an agent shall be accompanied by evidence of that agent's authority. (Bidders should retain a copy of their bid for their records.)

(c) Bidders must submit as part of their bid a completed form HUD-5369-A, "Representations, Certifications, and Other Statements of Bidders."

(d) All bid documents shall be sealed in an envelope which shall be clearly marked with the words "Bid Documents," the Invitation for Bids (IFB) number, any project or other identifying number, the bidder's name, and the date and time for receipt of bids.

(e) If this solicitation requires bidding on all items, failure to do so will disqualify the bid. If bidding on all items is not required, bidders should insert the words "No Bid" in the space provided for any item on which no price is submitted.

(f) Unless expressly authorized elsewhere in this solicitation, alternate bids will not be considered.

(g) Unless expressly authorized elsewhere in this solicitation, bids submitted by telegraph or facsimile (fax) machines will not be considered.

(h) If the proposed contract is for a Mutual Help project (as described in 24 CFR Part 905, Subpart E) that involves Mutual Help contributions of work, material, or equipment, supplemental information regarding the bid advertisement is provided as an attachment to this solicitation.

2. Explanations and Interpretations to Prospective Bidders

(a) Any prospective bidder desiring an explanation or interpretation of the solicitation, specifications, drawings, etc., must request it at least 7 days before the scheduled time for bid opening. Requests may be oral or written. Oral requests must be confirmed in writing. The only oral clarifications that will be provided will be those clearly related to solicitation procedures, i.e., not substantive technical information. No other oral explanation or interpretation will be provided. Any information given a prospective bidder concerning this solicitation will be furnished promptly to all other prospective bidders as a written amendment to the solicitation, if that information is necessary in submitting bids, or if the lack of it would be prejudicial to other prospective bidders.

(b) Any information obtained by, or provided to, a bidder other than by formal amendment to the solicitation shall not constitute a change to the solicitation.

3. Amendments to Invitations for Bids

(a) If this solicitation is amended, then all terms and conditions which are not modified remain unchanged.

(b) Bidders shall acknowledge receipt of any amendment to this solicitation (1) by signing and returning the amendment, (2) by identifying the amendment number and date on the bid form, or (3) by letter, telegram, or facsimile, if those methods are authorized in the solicitation. The PHA/IHA must receive acknowledgement by the time and at the place specified for receipt of bids. Bids which fail to acknowledge the bidder's receipt of any amendment will result in the rejection of the bid if the amendment(s) contained information which substantively changed the PHA's/IHA's requirements.

(c) Amendments will be on file in the offices of the PHA/IHA and the Architect at least 7 days before bid opening.

4. Responsibility of Prospective Contractor

(a) The PHA/IHA will award contracts only to responsible prospective contractors who have the ability to perform successfully under the terms and conditions of the proposed contract. In determining the responsibility of a bidder, the PHA/IHA will consider such matters as the bidder's:

- (1) Integrity;
- (2) Compliance with public policy;
- (3) Record of past performance; and
- (4) Financial and technical resources (including construction and technical equipment).

(b) Before a bid is considered for award, the bidder may be requested by the PHA/IHA to submit a statement or other documentation regarding any of the items in paragraph (a) above. Failure by the bidder to provide such additional information shall render the bidder nonresponsible and ineligible for award.

5. Late Submissions, Modifications, and Withdrawal of Bids

(a) Any bid received at the place designated in the solicitation after the exact time specified for receipt will not be considered unless it is received before award is made and it:

(1) Was sent by registered or certified mail not later than the fifth calendar day before the date specified for receipt of offers (e.g., an offer submitted in response to a solicitation requiring receipt of offers by the 20th of the month must have been mailed by the 15th);

(2) Was sent by mail, or if authorized by the solicitation, was sent by telegram or via facsimile, and it is determined by the PHA/IHA that the late receipt was due solely to mishandling by the PHA/IHA after receipt at the PHA/IHA; or

(3) Was sent by U.S. Postal Service Express Mail Next Day Service - Post Office to Addressee, not later than 5:00 p.m. at the place of mailing two working days prior to the date specified for receipt of proposals. The term "working days" excludes weekends and observed holidays.

(b) Any modification or withdrawal of a bid is subject to the same conditions as in paragraph (a) of this provision.

(c) The only acceptable evidence to establish the date of mailing of a late bid, modification, or withdrawal sent either by registered or certified mail is the U.S. or Canadian Postal Service postmark both on the envelope or wrapper and on the original receipt from the U.S. or Canadian Postal Service. Both postmarks must show a legible date or the bid, modification, or withdrawal shall be processed as if mailed late. "Postmark" means a printed, stamped, or otherwise placed impression (exclusive of a postage meter machine impression) that is readily identifiable without further action as having been supplied and affixed by employees of the U.S. or Canadian Postal Service on the date of mailing. Therefore, bidders should request the postal clerk to place a hand cancellation bull's-eye postmark on both the receipt and the envelope or wrapper.

(d) The only acceptable evidence to establish the time of receipt at the PHA/IHA is the time/date stamp of PHA/IHA on the proposal wrapper or other documentary evidence of receipt maintained by the PHA/IHA.

(e) The only acceptable evidence to establish the date of mailing of a late bid, modification, or withdrawal sent by Express Mail Next Day Service-Post Office to Addressee is the date entered by the post office receiving clerk on the "Express Mail Next Day Service-Post Office to Addressee" label and the postmark on both the envelope or wrapper and on the original receipt from the U.S. Postal Service. "Postmark" has the same meaning as defined in paragraph (c) of this provision, excluding postmarks of the Canadian Postal Service. Therefore, bidders should request the postal clerk to place a legible hand cancellation bull's eye postmark on both the receipt and Failure by a bidder to acknowledge receipt of the envelope or wrapper.

(f) Notwithstanding paragraph (a) of this provision, a late modification of an otherwise successful bid that makes its terms more favorable to the PHA/IHA will be considered at any time it is received and may be accepted.

(g) Bids may be withdrawn by written notice, or if authorized by this solicitation, by telegram (including mailgram) or facsimile machine transmission received at any time before the exact time set for opening of bids; provided that written confirmation of telegraphic or facsimile withdrawals over the signature of the bidder is mailed and postmarked prior to the specified bid opening time. A bid may be withdrawn in person by a bidder or its authorized representative if, before the exact time set for opening of bids, the identity of the person requesting withdrawal is established and the person signs a receipt for the bid.

6. Bid Opening

All bids received by the date and time of receipt specified in the solicitation will be publicly opened and read. The time and place of opening will be as specified in the solicitation. Bidders and other interested persons may be present.

7. Service of Protest

(a) Definitions. As used in this provision:

"Interested party" means an actual or prospective bidder whose direct economic interest would be affected by the award of the contract.

"Protest" means a written objection by an interested party to this solicitation or to a proposed or actual award of a contract pursuant to this solicitation.

(b) Protests shall be served on the Contracting Officer by obtaining written and dated acknowledgement from —

[Contracting Officer designate the official or location where a protest may be served on the Contracting Officer]

(c) All protests shall be resolved in accordance with the PHA's/IHA's protest policy and procedures, copies of which are maintained at the PHA/IHA.

8. Contract Award

(a) The PHA/IHA will evaluate bids in response to this solicitation without discussions and will award a contract to the responsible bidder whose bid, conforming to the solicitation, will be most advantageous to the PHA/IHA considering only price and any price-related factors specified in the solicitation.

(b) If the apparent low bid received in response to this solicitation exceeds the PHA's/IHA's available funding for the proposed contract work, the PHA/IHA may either accept separately priced items (see 8(e) below) or use the following procedure to determine contract award. The PHA/IHA shall apply in turn to each bid (proceeding in order from the apparent low bid to the high bid) each of the separately priced bid deductible items, if any, in their priority order set forth in this solicitation. If upon the application of the first deductible item to all initial bids, a new low bid is within the PHA's/IHA's available funding, then award shall be made to that bidder. If no bid is within the available funding amount, then the PHA/IHA shall apply the second deductible item. The PHA/IHA shall continue this process until an evaluated low bid, if any, is within the PHA's/IHA's available funding. If upon the application of all deductibles, no bid is within the PHA's/IHA's available funding, or if the solicitation does not request separately priced deductibles, the PHA/IHA shall follow its written policy and procedures in making any award under this solicitation.

(c) In the case of tie low bids, award shall be made in accordance with the PHA's/IHA's written policy and procedures.

(d) The PHA/IHA may reject any and all bids, accept other than the lowest bid (e.g., the apparent low bid is unreasonably low), and waive informalities or minor irregularities in bids received, in accordance with the PHA's/IHA's written policy and procedures.

(e) Unless precluded elsewhere in the solicitation, the PHA/IHA may accept any item or combination of items bid.

(f) The PHA/IHA may reject any bid as nonresponsive if it is materially unbalanced as to the prices for the various items of work to be performed. A bid is materially unbalanced when it is based on prices significantly less than cost for some work and prices which are significantly overstated for other work.

(g) A written award shall be furnished to the successful bidder within the period for acceptance specified in the bid and shall result in a binding contract without further action by either party.

9. Bid Guarantee (applicable to construction and equipment contracts exceeding \$25,000)

All bids must be accompanied by a negotiable bid guarantee which shall not be less than five percent (5%) of the amount of the bid. The bid guarantee may be a certified check, bank draft, U.S. Government Bonds at par value, or a bid bond secured by a surety company acceptable to the U.S. Government and authorized to do business in the state where the work is to be performed. In the case where the work under the contract will be performed on an Indian reservation area, the bid guarantee may also be an irrevocable Letter of Credit (see provision 10, Assurance of Completion, below). Certified checks and bank drafts must be made payable to the order of the PHA/IHA. The bid guarantee shall insure the execution of the contract and the furnishing of a method of assurance of completion by the successful bidder as required by the solicitation. Failure to submit a bid guarantee with the bid shall result in the rejection of the bid. Bid guarantees submitted by unsuccessful bidders will be returned as soon as practicable after bid opening.

10. Assurance of Completion

(a) Unless otherwise provided in State law, the successful bidder shall furnish an assurance of completion prior to the execution of any contract under this solicitation. This assurance may be [Contracting Officer check applicable items] —

[] (1) a performance and payment bond in a penal sum of 100 percent of the contract price; or, as may be required or permitted by State law;

[] (2) separate performance and payment bonds, each for 50 percent or more of the contract price;

[] (3) a 20 percent cash escrow;

[] (4) a 25 percent irrevocable letter of credit; or,

[] (5) an irrevocable letter of credit for 10 percent of the total contract price with a monitoring and disbursements agreement with the IHA (applicable only to contracts awarded by an IHA under the Indian Housing Program).

(b) Bonds must be obtained from guarantee or surety companies acceptable to the U.S. Government and authorized to do business in the state where the work is to be performed. Individual sureties will not be considered. U.S. Treasury Circular Number 570, published annually in the Federal Register, lists companies approved to act as sureties on bonds securing Government contracts, the maximum underwriting limits on each contract bonded, and the States in which the company is licensed to do business. Use of companies listed in this circular is mandatory. Copies of the circular may be downloaded on the U.S. Department of Treasury website <http://www.fms.treas.gov/c570/index.html>, or ordered for a minimum fee by contacting the Government Printing Office at (202) 512-2168.

(c) Each bond shall clearly state the rate of premium and the total amount of premium charged. The current power of attorney for the person who signs for the surety company must be attached to the bond. The effective date of the power of attorney shall not precede the date of the bond. The effective date of the bond shall be on or after the execution date of the contract.

(d) Failure by the successful bidder to obtain the required assurance of completion within the time specified, or within such extended period as the PHA/IHA may grant based upon reasons determined adequate by the PHA/IHA, shall render the bidder ineligible for award. The PHA/IHA may then either award the contract to the next lowest responsible bidder or solicit new bids. The PHA/IHA may retain the ineligible bidder's bid guarantee.

11. Preconstruction Conference (applicable to construction contracts)

After award of a contract under this solicitation and prior to the start of work, the successful bidder will be required to attend a preconstruction conference with representatives of the PHA/IHA and its architect/engineer, and other interested parties convened by the PHA/IHA. The conference will serve to acquaint the participants with the general plan of the construction operation and all other requirements of the contract (e.g., Equal Employment Opportunity, Labor Standards). The PHA/IHA will provide the successful bidder with the date, time, and place of the conference.

12. Indian Preference Requirements (applicable only if this solicitation is for a contract to be performed on a project for an Indian Housing Authority)

(a) HUD has determined that the contract awarded under this solicitation is subject to the requirements of section 7(b) of the Indian Self-Determination and Education Assistance Act (25 U.S.C. 450e(b)). Section 7(b) requires that any contract or subcontract entered into for the benefit of Indians shall require that, to the greatest extent feasible

(1) Preferences and opportunities for training and employment (other than core crew positions; see paragraph (h) below) in connection with the administration of such contracts or subcontracts be given to qualified "Indians." The Act defines "Indians" to mean persons who are members of an Indian tribe and defines "Indian tribe" to mean any Indian tribe, band, nation, or other organized group or community, including any Alaska Native village or regional or village corporation as defined in or established pursuant to the Alaska Native Claims Settlement Act, which is recognized as eligible for the special programs and services provided by the United States to Indians because of their status as Indians; and,

(2) Preference in the award of contracts or subcontracts in connection with the administration of contracts be given to Indian organizations and to Indian-owned economic enterprises, as defined in section 3 of the Indian Financing Act of 1974 (25 U.S.C. 1452). That Act defines "economic enterprise" to mean any Indian-owned commercial, industrial, or business activity established or organized for the purpose of profit, except that the Indian ownership must constitute not less than 51 percent of the enterprise; "Indian organization" to mean the governing body of any Indian tribe or entity established or recognized by such governing body; "Indian" to mean any person who is a member of any tribe, band, group, pueblo, or community which is recognized by the Federal Government as eligible for services from the Bureau of Indian Affairs and any "Native" as defined in the Alaska Native Claims Settlement Act; and Indian "tribe" to mean any Indian tribe, band, group, pueblo, or community including Native villages and Native groups (including

corporations organized by Kenai, Juneau, Sitka, and Kodiak) as defined in the Alaska Native Claims Settlement Act, which is recognized by the Federal Government as eligible for services from the Bureau of Indian Affairs.

(b) (1) The successful Contractor under this solicitation shall comply with the requirements of this provision in awarding all subcontracts under the contract and in providing training and employment opportunities.

(2) A finding by the IHA that the contractor, either (i) awarded a subcontract without using the procedure required by the IHA, (ii) falsely represented that subcontracts would be awarded to Indian enterprises or organizations; or, (iii) failed to comply with the contractor's employment and training preference bid statement shall be grounds for termination of the contract or for the assessment of penalties or other remedies.

(c) If specified elsewhere in this solicitation, the IHA may restrict the solicitation to qualified Indian-owned enterprises and Indian organizations. If two or more (or a greater number as specified elsewhere in the solicitation) qualified Indian-owned enterprises or organizations submit responsive bids, award shall be made to the qualified enterprise or organization with the lowest responsive bid. If fewer than the minimum required number of qualified Indian-owned enterprises or organizations submit responsive bids, the IHA shall reject all bids and readvertise the solicitation in accordance with paragraph (d) below.

(d) If the IHA prefers not to restrict the solicitation as described in paragraph (c) above, or if after having restricted a solicitation an insufficient number of qualified Indian enterprises or organizations submit bids, the IHA may advertise for bids from non-Indian as well as Indian-owned enterprises and Indian organizations. Award shall be made to the qualified Indian enterprise or organization with the lowest responsive bid if that bid is -

(1) Within the maximum HUD-approved budget amount established for the specific project or activity for which bids are being solicited; and

(2) No more than the percentage specified in 24 CFR 905.175(c) higher than the total bid price of the lowest responsive bid from any qualified bidder. If no responsive bid by a qualified Indian-owned economic enterprise or organization is within the stated range of the total bid price of the lowest responsive bid from any qualified enterprise, award shall be made to the bidder with the lowest bid.

(e) Bidders seeking to qualify for preference in contracting or subcontracting shall submit proof of Indian ownership with their bids. Proof of Indian ownership shall include but not be limited to:

(1) Certification by a tribe or other evidence that the bidder is an Indian. The IHA shall accept the certification of a tribe that an individual is a member.

(2) Evidence such as stock ownership, structure, management, control, financing and salary or profit sharing arrangements of the enterprise.

(f) (1) All bidders must submit with their bids a statement describing how they will provide Indian preference in the award of subcontracts. The specific requirements of that statement and the factors to be used by the IHA in determining the statement's adequacy are included as an attachment to this solicitation. Any bid that fails to include the required statement shall be rejected as nonresponsive. The IHA may require that comparable statements be provided by subcontractors to the successful Contractor, and may require the Contractor to reject any bid or proposal by a subcontractor that fails to include the statement.

(2) Bidders and prospective subcontractors shall submit a certification (supported by credible evidence) to the IHA in any instance where the bidder or subcontractor believes it is infeasible to provide Indian preference in subcontracting. The acceptance or rejection by the IHA of the certification shall be final. Rejection shall disqualify the bid from further consideration.

(g) All bidders must submit with their bids a statement detailing their employment and training opportunities and their plans to provide preference to Indians in implementing the contract; and the number or percentage of Indians anticipated to be employed and trained. Comparable statements from all proposed subcontractors must be submitted. The criteria to be used by the IHA in determining the statement(s)'s adequacy are included as an attachment to this solicitation. Any bid that fails to include the required statement(s), or that includes a statement that does not meet minimum standards required by the IHA shall be rejected as nonresponsive.

(h) Core crew employees. A core crew employee is an individual who is a bona fide employee of the contractor at the time the bid is submitted; or an individual who was not employed by the bidder at the time the bid was submitted, but who is regularly employed by the bidder in a supervisory or other key skilled position when work is available. Bidders shall submit with their bids a list of all core crew employees.

(i) Preference in contracting, subcontracting, employment, and training shall apply not only on-site, on the reservation, or within the IHA's jurisdiction, but also to contracts with firms that operate outside these areas (e.g., employment in modular or manufactured housing construction facilities).

(j) Bidders should contact the IHA to determine if any additional local preference requirements are applicable to this solicitation.

(k) The IHA [] does [] does not [Contracting Officer check applicable box] maintain lists of Indian-owned economic enterprises and Indian organizations by specialty (e.g., plumbing, electrical, foundations), which are available to bidders to assist them in meeting their responsibility to provide preference in connection with the administration of contracts and subcontracts.

**U.S. Department of Housing
and Urban Development**
Office of Public and Indian Housing

**Representations, Certifications,
and Other Statements of Bidders**
Public and Indian Housing Programs

Representations, Certifications, and Other Statements of Bidders

Public and Indian Housing Programs

Table of Contents

Clause	Page
1. Certificate of Independent Price Determination	1
2. Contingent Fee Representation and Agreement	1
3. Certification and Disclosure Regarding Payments to Influence Certain Federal Transactions	1
4. Organizational Conflicts of Interest Certification	2
5. Bidder's Certification of Eligibility	2
6. Minimum Bid Acceptance Period	2
7. Small, Minority, Women-Owned Business Concern Representation	2
8. Indian-Owned Economic Enterprise and Indian Organization Representation	2
9. Certification of Eligibility Under the Davis-Bacon Act	3
10. Certification of Nonsegregated Facilities	3
11. Clean Air and Water Certification	3
12. Previous Participation Certificate	3
13. Bidder's Signature	3

1. Certificate of Independent Price Determination

(a) The bidder certifies that--

(1) The prices in this bid have been arrived at independently, without, for the purpose of restricting competition, any consultation, communication, or agreement with any other bidder or competitor relating to (i) those prices, (ii) the intention to submit a bid, or (iii) the methods or factors used to calculate the prices offered;

(2) The prices in this bid have not been and will not be knowingly disclosed by the bidder, directly or indirectly, to any other bidder or competitor before bid opening (in the case of a sealed bid solicitation) or contract award (in the case of a competitive proposal solicitation) unless otherwise required by law; and

(3) No attempt has been made or will be made by the bidder to induce any other concern to submit or not to submit a bid for the purpose of restricting competition.

(b) Each signature on the bid is considered to be a certification by the signatory that the signatory--

(1) Is the person in the bidder's organization responsible for determining the prices being offered in this bid or proposal, and that the signatory has not participated and will not participate in any action contrary to subparagraphs (a)(1) through (a)(3) above; or

(2) (i) Has been authorized, in writing, to act as agent for the following principals in certifying that those principals have not participated, and will not participate in any action contrary to subparagraphs (a)(1) through (a)(3) above.

_____ [insert full name of person(s) in the bidder's organization responsible for determining the prices offered in this bid or proposal, and the title of his or her position in the bidder's organization];

(ii) As an authorized agent, does certify that the principals named in subdivision (b)(2)(i) above have not participated, and will not participate, in any action contrary to subparagraphs (a)(1) through (a)(3) above; and

(iii) As an agent, has not personally participated, and will not participate in any action contrary to subparagraphs (a)(1) through (a)(3) above.

(c) If the bidder deletes or modifies subparagraph (a)2 above, the bidder must furnish with its bid a signed statement setting forth in detail the circumstances of the disclosure.

[] [Contracting Officer check if following paragraph is applicable]

(d) Non-collusive affidavit. (applicable to contracts for construction and equipment exceeding \$50,000)

(1) Each bidder shall execute, in the form provided by the PHA/IHA, an affidavit to the effect that he/she has not colluded with any other person, firm or corporation in regard to any bid submitted in response to this solicitation. If the successful bidder did not submit the affidavit with his/her bid, he/she must submit it within three (3) working days of bid opening. Failure to submit the affidavit by that date may render the bid nonresponsive. No contract award will be made without a properly executed affidavit.

(2) A fully executed "Non-collusive Affidavit" [] is, [] is not included with the bid.

2. Contingent Fee Representation and Agreement

(a) Definitions. As used in this provision:

"Bona fide employee" means a person, employed by a bidder and subject to the bidder's supervision and control as to time, place, and manner of performance, who neither exerts, nor proposes to exert improper influence to solicit or obtain contracts nor holds out as being able to obtain any contract(s) through improper influence.

"Improper influence" means any influence that induces or tends to induce a PHA/IHA employee or officer to give consideration or to act regarding a PHA/IHA contract on any basis other than the merits of the matter.

(b) The bidder represents and certifies as part of its bid that, except for full-time bona fide employees working solely for the bidder, the bidder:

(1) [] has, [] has not employed or retained any person or company to solicit or obtain this contract; and

(2) [] has, [] has not paid or agreed to pay to any person or company employed or retained to solicit or obtain this contract any commission, percentage, brokerage, or other fee contingent upon or resulting from the award of this contract.

(c) If the answer to either (a)(1) or (a)(2) above is affirmative, the bidder shall make an immediate and full written disclosure to the PHA/IHA Contracting Officer.

(d) Any misrepresentation by the bidder shall give the PHA/IHA the right to (1) terminate the contract; (2) at its discretion, deduct from contract payments the amount of any commission, percentage, brokerage, or other contingent fee; or (3) take other remedy pursuant to the contract.

3. Certification and Disclosure Regarding Payments to Influence Certain Federal Transactions (applicable to contracts exceeding \$100,000)

(a) The definitions and prohibitions contained in Section 1352 of title 31, United States Code, are hereby incorporated by reference in paragraph (b) of this certification.

(b) The bidder, by signing its bid, hereby certifies to the best of his or her knowledge and belief as of December 23, 1989 that:

(1) No Federal appropriated funds have been paid or will be paid to any person for influencing or attempting to influence an officer or employee of any agency, a Member of Congress, an officer or employee of Congress, or an employee of a Member of Congress on his or her behalf in connection with the awarding of a contract resulting from this solicitation;

(2) If any funds other than Federal appropriated funds (including profit or fee received under a covered Federal transaction) have been paid, or will be paid, to any person for influencing or attempting to influence an officer or employee of any agency, a Member of Congress, an officer or employee of Congress, or an employee of a Member of Congress on his or her behalf in connection with this solicitation, the bidder shall complete and submit, with its bid, OMB standard form LLL, "Disclosure of Lobbying Activities;" and

(3) He or she will include the language of this certification in all subcontracts at any tier and require that all recipients of subcontract awards in excess of \$100,000 shall certify and disclose accordingly.

(c) Submission of this certification and disclosure is a prerequisite for making or entering into this contract imposed by section 1352, title 31, United States Code. Any person who makes an expenditure prohibited under this provision or who fails to file or amend the disclosure form to be filed or amended by this provision, shall be subject to a civil penalty of not less than \$10,000, and not more than \$100,000, for each such failure.

(d) Indian tribes (except those chartered by States) and Indian organizations as defined in section 4 of the Indian Self-Determination and Education Assistance Act (25 U.S.C. 450B) are exempt from the requirements of this provision.

4. Organizational Conflicts of Interest Certification

The bidder certifies that to the best of its knowledge and belief and except as otherwise disclosed, he or she does not have any organizational conflict of interest which is defined as a situation in which the nature of work to be performed under this proposed contract and the bidder's organizational, financial, contractual, or other interests may, without some restriction on future activities:

- (a) Result in an unfair competitive advantage to the bidder; or,
- (b) Impair the bidder's objectivity in performing the contract work.

[] In the absence of any actual or apparent conflict, I hereby certify that to the best of my knowledge and belief, no actual or apparent conflict of interest exists with regard to my possible performance of this procurement.

5. Bidder's Certification of Eligibility

(a) By the submission of this bid, the bidder certifies that to the best of its knowledge and belief, neither it, nor any person or firm which has an interest in the bidder's firm, nor any of the bidder's subcontractors, is ineligible to:

(1) Be awarded contracts by any agency of the United States Government, HUD, or the State in which this contract is to be performed; or,

(2) Participate in HUD programs pursuant to 24 CFR Part 24.

(b) The certification in paragraph (a) above is a material representation of fact upon which reliance was placed when making award. If it is later determined that the bidder knowingly rendered an erroneous certification, the contract may be terminated for default, and the bidder may be debarred or suspended from participation in HUD programs and other Federal contract programs.

6. Minimum Bid Acceptance Period

(a) "Acceptance period," as used in this provision, means the number of calendar days available to the PHA/IHA for awarding a contract from the date specified in this solicitation for receipt of bids.

(b) This provision supersedes any language pertaining to the acceptance period that may appear elsewhere in this solicitation.

(c) The PHA/IHA requires a minimum acceptance period of [Contracting Officer insert time period] calendar days.

(d) In the space provided immediately below, bidders may specify a longer acceptance period than the PHA's/IHA's minimum requirement. The bidder allows the following acceptance period: calendar days.

(e) A bid allowing less than the PHA's/IHA's minimum acceptance period will be rejected.

(f) The bidder agrees to execute all that it has undertaken to do, in compliance with its bid, if that bid is accepted in writing within (1) the acceptance period stated in paragraph (c) above or (2) any longer acceptance period stated in paragraph (d) above.

7. Small, Minority, Women-Owned Business Concern Representation

The bidder represents and certifies as part of its bid/ offer that it --

(a) [] is, [] is not a small business concern. "Small business concern," as used in this provision, means a concern, including its affiliates, that is independently owned and operated, not dominant in the field of operation in which it is bidding, and qualified as a small business under the criteria and size standards in 13 CFR 121.

(b) [] is, [] is not a women-owned business enterprise. "Women-owned business enterprise," as used in this provision, means a business that is at least 51 percent owned by a woman or women who are U.S. citizens and who also control and operate the business.

(c) [] is, [] is not a minority business enterprise. "Minority business enterprise," as used in this provision, means a business which is at least 51 percent owned or controlled by one or more minority group members or, in the case of a publicly owned business, at least 51 percent of its voting stock is owned by one or more minority group members, and whose management and daily operations are controlled by one or more such individuals. For the purpose of this definition, minority group members are:

(Check the block applicable to you)

- [] Black Americans
- [] Asian Pacific Americans
- [] Hispanic Americans
- [] Asian Indian Americans
- [] Native Americans
- [] Hasidic Jewish Americans

8. Indian-Owned Economic Enterprise and Indian Organization Representation (applicable only if this solicitation is for a contract to be performed on a project for an Indian Housing Authority)

The bidder represents and certifies that it:

(a) [] is, [] is not an Indian-owned economic enterprise. "Economic enterprise," as used in this provision, means any commercial, industrial, or business activity established or organized for the purpose of profit, which is at least 51 percent Indian owned. "Indian," as used in this provision, means any person who is a member of any tribe, band, group, pueblo, or community which is recognized by the Federal Government as eligible for services from the Bureau of Indian Affairs and any "Native" as defined in the Alaska Native Claims Settlement Act.

(b) [] is, [] is not an Indian organization. "Indian organization," as used in this provision, means the governing body of any Indian tribe or entity established or recognized by such governing body. Indian "tribe" means any Indian tribe, band, group, pueblo, or

community including Native villages and Native groups (including corporations organized by Kenai, Juneau, Sitka, and Kodiak) as defined in the Alaska Native Claims Settlement Act, which is recognized by the Federal Government as eligible for services from the Bureau of Indian Affairs.

9. Certification of Eligibility Under the Davis-Bacon Act (applicable to construction contracts exceeding \$2,000)

(a) By the submission of this bid, the bidder certifies that neither it nor any person or firm who has an interest in the bidder's firm is a person or firm ineligible to be awarded contracts by the United States Government by virtue of section 3(a) of the Davis-Bacon Act or 29 CFR 5.12(a)(1).

(b) No part of the contract resulting from this solicitation shall be subcontracted to any person or firm ineligible to be awarded contracts by the United States Government by virtue of section 3(a) of the Davis-Bacon Act or 29 CFR 5.12(a)(1).

(c) The penalty for making false statements is prescribed in the U. S. Criminal Code, 18 U.S.C. 1001.

10. Certification of Nonsegregated Facilities (applicable to contracts exceeding \$10,000)

(a) The bidder's attention is called to the clause entitled **Equal Employment Opportunity** of the General Conditions of the Contract for Construction.

(b) "Segregated facilities," as used in this provision, means any waiting rooms, work areas, rest rooms and wash rooms, restaurants and other eating areas, time clocks, locker rooms and other storage or dressing areas, parking lots, drinking fountains, recreation or entertainment areas, transportation, and housing facilities provided for employees, that are segregated by explicit directive or are in fact segregated on the basis of race, color, religion, or national origin because of habit, local custom, or otherwise.

(c) By the submission of this bid, the bidder certifies that it does not and will not maintain or provide for its employees any segregated facilities at any of its establishments, and that it does not and will not permit its employees to perform their services at any location under its control where segregated facilities are maintained. The bidder agrees that a breach of this certification is a violation of the Equal Employment Opportunity clause in the contract.

(d) The bidder further agrees that (except where it has obtained identical certifications from proposed subcontractors for specific time periods) prior to entering into subcontracts which exceed \$10,000 and are not exempt from the requirements of the Equal Employment Opportunity clause, it will:

(1) Obtain identical certifications from the proposed subcontractors;

(2) Retain the certifications in its files; and

(3) Forward the following notice to the proposed subcontractors (except if the proposed subcontractors have submitted identical certifications for specific time periods):

Notice to Prospective Subcontractors of Requirement for Certifications of Nonsegregated Facilities

A Certification of Nonsegregated Facilities must be submitted before the award of a subcontract exceeding \$10,000 which is not exempt from the provisions of the Equal Employment Opportunity clause of the prime contract. The certification may be submitted either for each subcontract or for all subcontracts during a period (i.e., quarterly, semiannually, or annually).

Note: The penalty for making false statements in bids is prescribed in 18 U.S.C. 1001.

11. Clean Air and Water Certification (applicable to contracts exceeding \$100,000)

The bidder certifies that:

(a) Any facility to be used in the performance of this contract [] is, [] is not listed on the Environmental Protection Agency List of Violating Facilities:

(b) The bidder will immediately notify the PHA/IHA Contracting Officer, before award, of the receipt of any communication from the Administrator, or a designee, of the Environmental Protection Agency, indicating that any facility that the bidder proposes to use for the performance of the contract is under consideration to be listed on the EPA List of Violating Facilities; and,

(c) The bidder will include a certification substantially the same as this certification, including this paragraph (c), in every nonexempt subcontract.

12. Previous Participation Certificate (applicable to construction and equipment contracts exceeding \$50,000)

(a) The bidder shall complete and submit with his/her bid the Form HUD-2530, "Previous Participation Certificate." If the successful bidder does not submit the certificate with his/her bid, he/she must submit it within three (3) working days of bid opening. Failure to submit the certificate by that date may render the bid nonresponsive. No contract award will be made without a properly executed certificate.

(b) A fully executed "Previous Participation Certificate" [] is, [] is not included with the bid.

13. Bidder's Signature

The bidder hereby certifies that the information contained in these certifications and representations is accurate, complete, and current.

(Signature and Date)

(Typed or Printed Name)

(Title)

(Company Name)

(Company Address)

General Conditions for Construction Contracts - Public Housing Programs

U.S. Department of Housing and Urban
Development
Office of Public and Indian Housing
OMB Approval No. 2577-0157 (exp. 11/30/2023)

**Applicability. This form is applicable to any
construction/development contract greater than \$250,000.**

Public reporting burden for this collection of information is estimated to average 1.0 hours per response, including the time for reviewing instructions, searching existing data sources, gathering and maintaining the data needed, and completing and reviewing the collection of information. Comments regarding the accuracy of this burden estimate and any suggestions for reducing this burden can be sent to the Reports Management Officer, Office of Policy Development and Research, REE, Department of Housing and Urban Development, 451 7th St SW, Room 4176, Washington, DC 20410-5000. When providing comments, please refer to OMB Approval No. 2577-0157. This form includes those clauses required by OMB's common rule on grantee procurement, implemented at HUD in 2 CFR 200, and those requirements set forth in Section 3 of the Housing and Urban Development Act of 1968 and its amendment by the Housing and Community Development Act of 1992, implemented by HUD at 24 CFR Part 75. The form is required for construction contracts awarded by Public Housing Agencies (PHAs). The form is used by Housing Authorities in solicitations to provide necessary contract clauses. If the form were not used, PHAs would be unable to enforce their contracts. Responses to the collection of information are required to obtain a benefit or to retain a benefit. The information requested does not lend itself to confidentiality. HUD may not conduct or sponsor, and a person is not required to respond to a collection of information unless it displays a currently valid OMB number.

Clause		Page	Clause		Page
1.	Definitions	2	Administrative Requirements		
2.	Contractor's Responsibility for Work	2	25.	Contract Period	9
3.	Architect's Duties, Responsibilities and Authority	2	26.	Order of Precedence	9
4.	Other Contracts	3	27.	Payments	9
	Construction Requirements		28.	Contract Modifications	10
5.	Preconstruction Conference and Notice to Proceed	3	29.	Changes	10
6.	Construction Progress Schedule	3	30.	Suspension of Work	11
7.	Site Investigation and Conditions Affecting the Work	3	31.	Disputes	11
8.	Differing Site Conditions	4	32.	Default	11
9.	Specifications and Drawings for Construction	4	33.	Liquidated	12
10.	As-Built Drawings	5	34.	Termination of Convenience	12
11.	Material and Workmanship	5	35.	Assignment of Contract	12
12.	Permits and Codes	5	36.	Insurance	12
13.	Health, Safety, and Accident Prevention	6	37.	Subcontracts	13
14.	Temporary Buildings and Transportation Materials	6	38.	Subcontracting with Small and Minority Firms, Women's Business Enterprise, and Labor Surplus Area Firms	13
15.	Availability and Use of Utility Services	6	39.	Equal Employment Opportunity	13
16.	Protection of Existing Vegetation, Structures, Equipment, Utilities, and Improvements	6	40.	Employment, Training, and Contracting Opportunities for Low-Income Persons, Section 3 of the Housing and Urban Development Act of 1968	14
17.	Temporary Buildings and Transportation Materials	7	41.	Interest of Members of Congress	15
18.	Clean Air and Water	7	42.	Interest of Members, Officers, or Employees and Former Members, Officers, or Employees	15
19.	Energy Efficiency	7	43.	Limitations on Payments Made to Influence	15
20.	Inspection and Acceptance of Construction	7	44.	Royalties and Patents	15
21.	Use and Possession Prior to	8	45.	Examination and Retention of Contractor's Records	15
22.	Warranty of Title	8	46.	Labor Standards-Davis-Bacon and Related Acts	15
23.	Warranty of	8	47.	Non-Federal Prevailing Wage Rates	19
24.	Prohibition Against	9	48.	Procurement of Recovered	19
	Liens			Materials	

1. Definitions

- (a) "Architect" means the person or other entity engaged by the PHA to perform architectural, engineering, design, and other services related to the work as provided for in the contract. When a PHA uses an engineer to act in this capacity, the terms "architect" and "engineer" shall be synonymous. The Architect shall serve as a technical representative of the Contracting Officer. The Architect's authority is as set forth elsewhere in this contract.
- (b) "Contract" means the contract entered into between the PHA and the Contractor. It includes the forms of Bid, the Bid Bond, the Performance and Payment Bond or Bonds or other assurance of completion, the Certifications, Representations, and Other Statements of Bidders (form HUD-5370), these General Conditions of the Contract for Construction (form HUD-5370), the applicable wage rate determinations from the U.S. Department of Labor, any special conditions included elsewhere in the contract, the specifications, and drawings. It includes all formal changes to any of those documents by addendum, change order, or other modification.
- (c) "Contracting Officer" means the person delegated the authority by the PHA to enter into, administer, and/or terminate this contract and designated as such in writing to the Contractor. The term includes any successor Contracting Officer and any duly authorized representative of the Contracting Officer also designated in writing. The Contracting Officer shall be deemed the authorized agent of the PHA in all dealings with the Contractor.
- (d) "Contractor" means the person or other entity entering into the contract with the PHA to perform all of the work required under the contract.
- (e) "Drawings" means the drawings enumerated in the schedule of drawings contained in the Specifications and as described in the contract clause entitled Specifications and Drawings for Construction herein.
- (f) "HUD" means the United States of America acting through the Department of Housing and Urban Development including the Secretary, or any other person designated to act on its behalf. HUD has agreed, subject to the provisions of an Annual Contributions Terms and Conditions (ACC), to provide financial assistance to the PHA, which includes assistance in financing the work to be performed under this contract. As defined elsewhere in these General Conditions or the contract documents, the determination of HUD may be required to authorize changes in the work or for release of funds to the PHA for payment to the Contractor. Notwithstanding HUD's role, nothing in this contract shall be construed to create any contractual relationship between the Contractor and HUD.
- (g) "Project" means the entire project, whether construction or rehabilitation, the work for which is provided for in whole or in part under this contract.
- (h) "PHA" means the Public Housing Agency organized under applicable state laws which is a party to this contract.
- (j) "Specifications" means the written description of the technical requirements for construction and includes the criteria and tests for determining whether the requirements are met.
- (l) "Work" means materials, workmanship, and manufacture and fabrication of components.

2. Contractor's Responsibility for Work

- (a) The Contractor shall furnish all necessary labor, materials, tools, equipment, and transportation necessary for performance of the work. The Contractor shall also furnish all necessary water, heat, light, and power not made available to the Contractor by the PHA pursuant to the clause entitled Availability and Use of Utility Services herein.
- (b) The Contractor shall perform on the site, and with its own organization, work equivalent to at least [] (12 percent unless otherwise indicated) of the total amount of work to be performed under the order. This percentage may be reduced by a supplemental agreement to this order if, during performing the work, the Contractor requests a reduction and the Contracting Officer determines that the reduction would be to the advantage of the PHA.
- (c) At all times during performance of this contract and until the work is completed and accepted, the Contractor shall directly superintend the work or assign and have on the work site a competent superintendent who is satisfactory to the Contracting Officer and has authority to act for the Contractor.
- (d) The Contractor shall be responsible for all damages to persons or property that occur as a result of the Contractor's fault or negligence, and shall take proper safety and health precautions to protect the work, the workers, the public, and the property of others. The Contractor shall hold and save the PHA, its officers and agents, free and harmless from liability of any nature occasioned by the Contractor's performance. The Contractor shall also be responsible for all materials delivered and work performed until completion and acceptance of the entire work, except for any completed unit of work which may have been accepted under the contract.
- (e) The Contractor shall lay out the work from base lines and bench marks indicated on the drawings and be responsible for all lines, levels, and measurements of all work executed under the contract. The Contractor shall verify the figures before laying out the work and will be held responsible for any error resulting from its failure to do so.
- (f) The Contractor shall confine all operations (including storage of materials) on PHA premises to areas authorized or approved by the Contracting Officer.
- (g) The Contractor shall at all times keep the work area, including storage areas, free from accumulations of waste materials. After completing the work and before final inspection, the Contractor shall (1) remove from the premises all scaffolding, equipment, tools, and materials (including rejected materials) that are not the property of the PHA and all rubbish caused by its work; (2) leave the work area in a clean, neat, and orderly condition satisfactory to the Contracting Officer; (3) perform all specified tests; and, (4) deliver the installation in complete and operating condition.
- (h) The Contractor's responsibility will terminate when all work has been completed, the final inspection made, and the work accepted by the Contracting Officer. The Contractor will then be released from further obligation except as required by the warranties specified elsewhere in the contract.

3. Architect's Duties, Responsibilities, and Authority

- (a) The Architect for this contract, and any successor, shall be designated in writing by the Contracting Officer.

- (b) The Architect shall serve as the Contracting Officer's technical representative with respect to architectural, **Schedule** engineering, and design matters related to the work performed under the contract. The Architect may provide direction on contract performance. Such direction shall be within the scope of the contract and may not be of a nature which: (1) institutes additional work outside the scope of the contract; (2) constitutes a change as defined in the Changes clause herein; (3) causes an increase or decrease in the cost of the contract; (4) alters the Construction Progress Schedule; or (5) changes any of the other express terms or conditions of the contract.
- (c) The Architect's duties and responsibilities may include but shall not be limited to:
- (1) Making periodic visits to the work site, and on the basis of his/her on-site inspections, issuing written reports to the PHA which shall include all observed deficiencies. The Architect shall file a copy of the report with the Contractor's designated representative at the site;
 - (2) Making modifications in drawings and technical specifications and assisting the Contracting Officer in the preparation of change orders and other contract modifications for issuance by the Contracting Officer;
 - (3) Reviewing and making recommendations with respect to - (i) the Contractor's construction progress schedules; (ii) the Contractor's shop and detailed drawings; (iii) the machinery, mechanical and other equipment and materials or other articles proposed for use by the Contractor; and, (iv) the Contractor's price breakdown and progress payment estimates; and,
 - (4) Assisting in inspections, signing Certificates of Completion, and making recommendations with respect to acceptance of work completed under the contract.

4. Other Contracts

The PHA may undertake or award other contracts for additional work at or near the site of the work under this contract. The Contractor shall fully cooperate with the other contractors and with PHA employees and shall carefully adapt scheduling and performing the work under this contract to accommodate the additional work, heeding any direction that may be provided by the Contracting Officer. The Contractor shall not commit or permit any act that will interfere with the performance of work by any other contractor or by PHA employees

Construction Requirements

5. Pre-construction Conference and Notice to Proceed

of the work, and that it has investigated and satisfied itself

- (a) Within ten calendar days of contract execution, and prior to the commencement of work, the Contractor shall attend a preconstruction conference with representatives of the PHA, its Architect, and other interested parties convened by the PHA. The conference will serve to acquaint the participants with the general plan of the construction operation and all other requirements of the contract. The PHA will provide the Contractor with the date, time, and place of the conference.
- (b) The contractor shall begin work upon receipt of a written Notice to Proceed from the Contracting Officer or designee. The Contractor shall not begin work prior to receiving such notice.

6. Construction Progress

- (a) The Contractor shall, within five days after the work commences on the contract or another period of time determined by the Contracting Officer, prepare and submit to the Contracting Officer for approval three copies of a practicable schedule showing the order in which the Contractor proposes to perform the work, and the dates on which the Contractor contemplates starting and completing the several salient features of the work (including acquiring labor, materials, and equipment). The schedule shall be in the form of a progress chart of suitable scale to indicate appropriately the percentage of work scheduled for completion by any given date during the period. If the Contractor fails to submit a schedule within the time prescribed, the Contracting Officer may withhold approval of progress payments or take other remedies under the contract until the Contractor submits the required schedule.
- (b) The Contractor shall enter the actual progress on the chart as required by the Contracting Officer, and immediately deliver three copies of the annotated schedule to the Contracting Officer. If the Contracting Officer determines, upon the basis of inspection conducted pursuant to the clause entitled Inspection and Acceptance of Construction, herein that the Contractor is not meeting the approved schedule, the Contractor shall take steps necessary to improve its progress, including those that may be required by the Contracting Officer, without additional cost to the PHA. In this circumstance, the Contracting Officer may require the Contractor to increase the number of shifts, overtime operations, days of work, and/or the amount of construction plant, and to submit for approval any supplementary schedule or schedules in chart form as the Contracting Officer deems necessary to demonstrate how the approved rate of progress will be regained.
- (c) Failure of the Contractor to comply with the requirements of the Contracting Officer under this clause shall be grounds for a determination by the Contracting Officer that the Contractor is not prosecuting the work with sufficient diligence to ensure completion within the time specified in the Contract. Upon making this determination, the Contracting Officer may terminate the Contractor's right to proceed with the work, or any separable part of it, in accordance with the Default clause of this contract.

7. Site Investigation and Conditions Affecting the Work

- (a) The Contractor acknowledges that it has taken steps reasonably necessary to ascertain the nature and location as to the general and local conditions which can affect the work or its cost, including but not limited to, (1) conditions bearing upon transportation, disposal, handling, and storage of materials; (2) the availability of labor, water, electric power, and roads; (3) uncertainties of weather, river stages, tides, or similar physical conditions at the site; (4) the conformation and conditions of the ground; and (5) the character of equipment and facilities needed preliminary to and during work performance. The Contractor also acknowledges that it has satisfied itself as to the character, quality, and quantity of surface and subsurface materials or obstacles to be encountered insofar as this information is

reasonably ascertainable from an inspection of the site, including all exploratory work done by the PHA, as well as from the drawings and specifications made a part of this contract. Any failure of the Contractor to take the actions described and acknowledged in this paragraph will not relieve the Contractor from responsibility for estimating properly the difficulty and cost of successfully performing the work, or for proceeding to successfully perform the work without additional expense to the PHA.

- (b) The PHA assumes no responsibility for any conclusions or interpretations made by the Contractor based on the information made available by the PHA. Nor does the PHA assume responsibility for any understanding reached or representation made concerning conditions which can affect the work by any of its officers or agents before the execution of this contract, unless that understanding or representation is expressly stated in this contract.

8. Differing Site Conditions

(a) The Contractor shall promptly, and before the conditions are disturbed, give a written notice to the Contracting Officer of (1) subsurface or latent physical conditions at the site which differ materially from those indicated in this contract, or (2) unknown physical conditions at the site(s), of an unusual nature, which differ materially from those ordinarily encountered and generally recognized as inhering in work of the character provided for in the contract.

(b) The Contracting Officer shall investigate the site conditions promptly after receiving the notice. Work shall not proceed at the affected site, except at the

Contractor's risk, until the Contracting Officer has provided written instructions to the Contractor. If the conditions do materially so differ and cause an increase or decrease in the Contractor's cost of, or the time required for, performing any part of the work under this contract, whether or not changed as a result of the conditions, the Contractor shall file a claim in writing to the PHA within ten days after receipt of such instructions and, in any event, before proceeding with the work. An equitable adjustment in the contract price, the delivery schedule, or both shall be made under this clause and the contract modified in writing accordingly.

(c) No request by the Contractor for an equitable adjustment to the contract under this clause shall be allowed, unless the Contractor has given the written notice required; provided, that the time prescribed in (a) above for giving written notice may be extended by the Contracting Officer.

(d) No request by the Contractor for an equitable adjustment to the contract for differing site conditions shall be allowed if made after final payment under this contract.

9. Specifications and Drawings for Construction

(a) The Contractor shall keep on the work site a copy of the drawings and specifications and shall at all times give the Contracting Officer access thereto. Anything mentioned in the specifications and not shown on the drawings, or shown on the drawings and not mentioned in the specifications, shall be of like effect as if shown or mentioned in both. In case of difference between drawings and specifications, the specifications shall govern. In case of discrepancy in the figures, in the drawings, or in the specifications, the matter shall be

promptly submitted to the Contracting Officer, who shall promptly make a determination in writing. Any adjustment by the Contractor without such a determination shall be at its own risk and expense. The Contracting Officer shall furnish from time to time such detailed drawings and other information as considered necessary, unless otherwise provided.

(b) Wherever in the specifications or upon the drawings the words "directed", "required", "ordered", "designated", "prescribed", or words of like import are used, it shall be understood that the "direction", "requirement", "order", "designation", or "prescription", of the Contracting Officer is intended and similarly the words "approved", "acceptable", "satisfactory", or words of like import shall mean "approved by", or "acceptable to", or "satisfactory to" the Contracting Officer, unless otherwise expressly stated.

(c) Where "as shown" "as indicated", "as detailed", or words of similar import are used, it shall be understood that the reference is made to the drawings accompanying this contract unless stated otherwise. The word "provided" as used herein shall be understood to mean "provide complete in place" that is "furnished and installed".

(d) "Shop drawings" means drawings, submitted to the PHA by the Contractor, subcontractor, or any lower tier subcontractor, showing in detail (1) the proposed fabrication and assembly of structural elements and (2) the installation (i.e., form, fit, and attachment details) of materials of equipment. It includes drawings, diagrams, layouts, schematics, descriptive literature, illustrations, schedules, performance and test data, and similar materials furnished by the Contractor to explain in detail specific portions of the work required by the contract. The PHA may duplicate, use, and disclose in any manner and for any purpose shop drawings delivered under this contract.

(e) If this contract requires shop drawings, the Contractor shall coordinate all such drawings, and review them for accuracy, completeness, and compliance with other contract requirements and shall indicate its approval thereon as evidence of such coordination and review. Shop drawings submitted to the Contracting Officer without evidence of the Contractor's approval may be returned for resubmission. The Contracting Officer will indicate an approval or disapproval of the shop drawings and if not approved as submitted shall indicate the PHA's reasons therefore. Any work done before such approval shall be at the Contractor's risk. Approval by the Contracting Officer shall not relieve the Contractor from responsibility for any errors or omissions in such drawings, nor from responsibility for complying with the requirements of this contract, except with respect to variations described and approved in accordance with (f) below.

(f) If shop drawings show variations from the contract requirements, the Contractor shall describe such variations in writing, separate from the drawings, at the time of submission. If the Architect approves any such variation and the Contracting Officer concurs, the Contracting Officer shall issue an appropriate modification to the contract, except that, if the variation is minor or does not involve a change in price or in time of performance, a modification need not be issued.

(g) It shall be the responsibility of the Contractor to make timely requests of the PHA for such large scale and full size drawings, color schemes, and other additional information, not already in his possession, which shall be

required in the planning and production of the work. Such requests may be submitted as the need arises, but each such request shall be filed in ample time to permit appropriate action to be taken by all parties involved so as to avoid delay.

- (h) The Contractor shall submit to the Contracting Officer for approval four copies (unless otherwise indicated) of all shop drawings as called for under the various headings of these specifications. Three sets (unless otherwise indicated) of all shop drawings, will be retained by the PHA and one set will be returned to the Contractor. As required by the Contracting Officer, the Contractor, upon completing the work under this contract, shall furnish a complete set of all shop drawings as finally approved. These drawings shall show all changes and revisions made up to the time the work is completed and accepted.
- (i) This clause shall be included in all subcontracts at any tier. It shall be the responsibility of the Contractor to ensure that all shop drawings prepared by subcontractors are submitted to the Contracting Officer.

10. As-Built Drawings

- (a) "As-built drawings," as used in this clause, means drawings submitted by the Contractor or subcontractor at any tier to show the construction of a particular structure or work as actually completed under the contract. "As-built drawings" shall be synonymous with "Record drawings."
- (b) As required by the Contracting Officer, the Contractor shall provide the Contracting Officer accurate information to be used in the preparation of permanent as-built drawings. For this purpose, the Contractor shall record on one set of contract drawings all changes from the installations originally indicated, and record final locations of underground lines by depth from finish grade and by accurate horizontal offset distances to permanent surface improvements such as buildings, curbs, or edges of walks.
- (c) This clause shall be included in all subcontracts at any tier. It shall be the responsibility of the Contractor to ensure that all as-built drawings prepared by subcontractors are submitted to the Contracting Officer.

11. Material and Workmanship

- (a) All equipment, material, and articles furnished under this contract shall be new and of the most suitable grade for the purpose intended, unless otherwise specifically provided in this contract. References in the contract to equipment, material, articles, or patented processes by trade name, make, or catalog number, shall be regarded as establishing a standard of quality and shall not be construed as limiting competition. The Contractor may, at its option, use any equipment, material, article, or process that, in the judgment of, and as approved by the Contracting Officer, is equal to that named in the specifications, unless otherwise specifically provided in this contract.
- (b) Approval of equipment and materials.
- (1) The Contractor shall obtain the Contracting Officer's approval of the machinery and mechanical and other equipment to be incorporated into the work. When requesting approval, the Contractor shall furnish to the Contracting Officer the name of the manufacturer, the model number, and other information concerning the performance, capacity, nature, and rating of the

machinery and mechanical and other equipment. When required by this contract or by the Contracting Officer, the Contractor shall also obtain the Contracting Officer's approval of the material or articles which the Contractor contemplates incorporating into the work. When requesting approval, the Contractor shall provide full information concerning the material or articles. Machinery, equipment, material, and articles that do not have the required approval shall be installed or used at the risk of subsequent rejection.

- (2) When required by the specifications or the Contracting Officer, the Contractor shall submit appropriately marked samples (and certificates related to them) for approval at the Contractor's expense, with all shipping charges prepaid. The Contractor shall label, or otherwise properly mark on the container, the material or product represented, its place of origin, the name of the producer, the Contractor's name, and the identification of the construction project for which the material or product is intended to be used.
- (3) Certificates shall be submitted in triplicate, describing each sample submitted for approval and certifying that the material, equipment or accessory complies with contract requirements. The certificates shall include the name and brand of the product, name of manufacturer, and the location where produced.
- (4) Approval of a sample shall not constitute a waiver of the PHA right to demand full compliance with contract requirements. Materials, equipment and accessories may be rejected for cause even though samples have been approved.
- (5) Wherever materials are required to comply with recognized standards or specifications, such specifications shall be accepted as establishing the technical qualities and testing methods, but shall not govern the number of tests required to be made nor modify other contract requirements. The Contracting Officer may require laboratory test reports on items submitted for approval or may approve materials on the basis of data submitted in certificates with samples. Check tests will be made on materials delivered for use only as frequently as the Contracting Officer determines necessary to insure compliance of materials with the specifications. The Contractor will assume all costs of retesting materials which fail to meet contract requirements and/or testing materials offered in substitution for those found deficient.
- (6) After approval, samples will be kept in the Project office until completion of work. They may be built into the work after a substantial quantity of the materials they represent has been built in and accepted.
- (c) Requirements concerning lead-based paint. The Contractor shall comply with the requirements concerning lead-based paint contained in the Lead-Based Paint Poisoning Prevention Act (42 U.S.C. 4821-4846) as implemented by 24 CFR Part 35.

12. Permits and Codes

- (a) The Contractor shall give all notices and comply with all applicable laws, ordinances, codes, rules and regulations. Notwithstanding the requirement of the Contractor to comply with the drawings and specifications in the contract, all work installed shall comply with all applicable codes and regulations as amended by any

waivers. Before installing the work, the Contractor shall examine the drawings and the specifications for compliance with applicable codes and regulations bearing on the work and shall immediately report any discrepancy it may discover to the Contracting Officer.

Where the requirements of the drawings and specifications fail to comply with the applicable code or regulation, the Contracting Officer shall modify the contract by change order pursuant to the clause entitled Changes herein to conform to the code or regulation.

- (b) The Contractor shall secure and pay for all permits, fees, and licenses necessary for the proper execution and completion of the work. Where the PHA can arrange for the issuance of all or part of these permits, fees and licenses, without cost to the Contractor, the contract amount shall be reduced accordingly.

13. Health, Safety, and Accident Prevention

(a) In performing this contract, the Contractor shall:

- (1) Ensure that no laborer or mechanic shall be required to work in surroundings or under working conditions which are unsanitary, hazardous, or dangerous to his/her health and/or safety as determined under construction safety and health standards promulgated by the Secretary of Labor by regulation;
- (2) Protect the lives, health, and safety of other persons;
- (3) Prevent damage to property, materials, supplies, and equipment; and,
- (4) Avoid work interruptions.

(b) For these purposes, the Contractor shall:

- (1) Comply with regulations and standards issued by the Secretary of Labor at 29 CFR Part 1926. Failure to comply may result in imposition of sanctions pursuant to the Contract Work Hours and Safety Standards Act (Public Law 91-54, 83 Stat. 96), 40 U.S.C. 3701 et seq.; and
- (2) Include the terms of this clause in every subcontract so that such terms will be binding on each subcontractor.

(c) The Contractor shall maintain an accurate record of exposure data on all accidents incident to work performed under this contract resulting in death, traumatic injury, occupational disease, or damage to property, materials, supplies, or equipment, and shall report this data in the manner prescribed by 29 CFR Part 1904.

(d) The Contracting Officer shall notify the Contractor of any noncompliance with these requirements and of the corrective action required. This notice, when delivered to the Contractor or the Contractor's representative at the site of the work, shall be deemed sufficient notice of the noncompliance and corrective action required. After receiving the notice, the Contractor shall immediately take corrective action. If the Contractor fails or refuses to take corrective action promptly, the Contracting Officer may issue an order stopping all or part of the work until satisfactory corrective action has been taken. The Contractor shall not base any claim or request for equitable adjustment for additional time or money on any stop order issued under these circumstances.

(e) The Contractor shall be responsible for its subcontractors' compliance with the provisions of this clause. The Contractor shall take such action with respect to any subcontract as the PHA, the Secretary of Housing and Urban Development, or the Secretary of Labor shall direct as a means of enforcing such provisions.

14. Temporary Heating

The Contractor shall provide and pay for temporary heating, covering, and enclosures necessary to properly protect all work and materials against damage by dampness and cold, to dry out the work, and to facilitate the completion of the work. Any permanent heating equipment used shall be turned over to the PHA in the condition and at the time required by the specifications.

15. Availability and Use of Utility Services

(a) The PHA shall make all reasonably required amounts of utilities available to the Contractor from existing outlets and supplies, as specified in the contract. Unless otherwise provided in the contract, the amount of each utility service consumed shall be charged to or paid for by the Contractor at prevailing rates charged to the PHA or, where the utility is produced by the PHA, at reasonable rates determined by the Contracting Officer. The Contractor shall carefully conserve any utilities furnished without charge.

(b) The Contractor, at its expense and in a manner satisfactory to the Contracting Officer, shall install and maintain all necessary temporary connections and distribution lines, and all meters required to measure the amount of each utility used for the purpose of determining charges. Before final acceptance of the work by the PHA, the Contractor shall remove all the temporary connections, distribution lines, meters, and associated paraphernalia.

16. Protection of Existing Vegetation, Structures, Equipment, Utilities, and Improvements

(a) The Contractor shall preserve and protect all structures, equipment, and vegetation (such as trees, shrubs, and grass) on or adjacent to the work site, which are not to be removed under this contract, and which do not unreasonably interfere with the work required under this contract.

(b) The Contractor shall only remove trees when specifically authorized to do so, and shall avoid damaging vegetation that will remain in place. If any limbs or branches of trees are broken during performance of this contract, or by the careless operation of equipment, or by workmen, the Contractor shall trim those limbs or branches with a clean cut and paint the cut with a tree-pruning compound as directed by the Contracting Officer.

(c) The Contractor shall protect from damage all existing improvements and utilities (1) at or near the work site and (2) on adjacent property of a third party, the locations of which are made known to or should be known by the Contractor. Prior to disturbing the ground at the construction site, the Contractor shall ensure that all underground utility lines are clearly marked.

(d) The Contractor shall shore up, brace, underpin, secure, and protect as necessary all foundations and other parts of existing structures adjacent to, adjoining, and in the vicinity of the site, which may be affected by the excavations or other operations connected with the construction of the project.

(e) Any equipment temporarily removed as a result of work under this contract shall be protected, cleaned, and replaced in the same condition as at the time of award of this contract.

- (f) New work which connects to existing work shall correspond in all respects with that to which it connects and/or be similar to existing work unless otherwise required by the specifications.
- (g) No structural members shall be altered or in any way weakened without the written authorization of the Contracting Officer, unless such work is clearly specified in the plans or specifications.
- (h) If the removal of the existing work exposes discolored or unfinished surfaces, or work out of alignment, such surfaces shall be refinished, or the material replaced as necessary to make the continuous work uniform and harmonious. This, however, shall not be construed to require the refinishing or reconstruction of dissimilar finishes previously exposed, or finished surfaces in good condition, but in different planes or on different levels **Construction** when brought together by the removal of intervening work, unless such refinishing or reconstruction is specified in the plans or specifications.
- (i) The Contractor shall give all required notices to any adjoining or adjacent property owner or other party before the commencement of any work.
- (j) The Contractor shall indemnify and save harmless the PHA from any damages on account of settlement or the loss of lateral support of adjoining property, any damages from changes in topography affecting drainage, and from all loss or expense and all damages for which the PHA may become liable in consequence of such injury or damage to adjoining and adjacent structures and their premises.
- (k) The Contractor shall repair any damage to vegetation, structures, equipment, utilities, or improvements, including those that are the property of a third party, resulting from failure to comply with the requirements of this contract or failure to exercise reasonable care in performing the work. If the Contractor fails or refuses to repair the damage promptly, the Contracting Officer may have the necessary work performed and charge the cost to the Contractor.

17. Temporary Buildings and Transportation of Materials

- (a) Temporary buildings (e.g., storage sheds, shops, offices, sanitary facilities) and utilities may be erected by the Contractor only with the approval of the Contracting Officer and shall be built with labor and materials furnished by the Contractor without expense to the PHA. The temporary buildings and utilities shall remain the property of the Contractor and shall be removed by the Contractor at its expense upon completion of the work. With the written consent of the Contracting Officer, the buildings and utilities may be abandoned and need not be removed.
- (b) The Contractor shall, as directed by the Contracting Officer, use only established roadways, or use temporary roadways constructed by the Contractor when and as authorized by the Contracting Officer. When materials are transported in prosecuting the work, vehicles shall not be loaded beyond the loading capacity recommended by the manufacturer of the vehicle or prescribed by any federal, state, or local law or regulation. When it is necessary to cross curbs or sidewalks, the Contractor shall protect them from damage. The Contractor shall repair or pay for the repair of any damaged curbs, sidewalks, or roads.

18. Clean Air and Water

The contractor shall comply with the Clean Air Act, as amended, 42 USC 7401 et seq., the Federal Water Pollution Control Water Act, as amended, 33 U.S.C. 1251 et seq., and standards issued pursuant thereto in the facilities in which this contract is to be performed.

19. Energy Efficiency

The Contractor shall comply with mandatory standards and policies relating to energy efficiency which are contained in the energy conservation plan issued in compliance with the Energy Policy and Conservation Act (Pub.L. 94-163) for the State in which the work under the contract is performed.

20. Inspection and Acceptance of

- (a) Definitions. As used in this clause -
- (1) "Acceptance" means the act of an authorized representative of the PHA by which the PHA approves and assumes ownership of the work performed under this contract. Acceptance may be partial or complete.
- (2) "Inspection" means examining and testing the work performed under the contract (including, when appropriate, raw materials, equipment, components, and intermediate assemblies) to determine whether it conforms to contract requirements.
- (3) "Testing" means that element of inspection that determines the properties or elements, including functional operation of materials, equipment, or their components, by the application of established scientific principles and procedures.
- (b) The Contractor shall maintain an adequate inspection system and perform such inspections as will ensure that the work performed under the contract conforms to contract requirements. All work is subject to PHA inspection and test at all places and at all reasonable times before acceptance to ensure strict compliance with the terms of the contract.
- (c) PHA inspections and tests are for the sole benefit of the PHA and do not: (1) relieve the Contractor of responsibility for providing adequate quality control measures; (2) relieve the Contractor of responsibility for loss or damage of the material before acceptance; (3) constitute or imply acceptance; or, (4) affect the continuing rights of the PHA after acceptance of the completed work under paragraph (j) below.
- (d) The presence or absence of the PHA inspector does not relieve the Contractor from any contract requirement, nor is the inspector authorized to change any term or condition of the specifications without the Contracting Officer's written authorization. All instructions and approvals with respect to the work shall be given to the Contractor by the Contracting Officer.
- (e) The Contractor shall promptly furnish, without additional charge, all facilities, labor, and material reasonably needed for performing such safe and convenient inspections and tests as may be required by the Contracting Officer. The PHA may charge to the Contractor any additional cost of inspection or test when work is not ready at the time specified by the Contractor for inspection or test, or when prior rejection makes reinspection or retest necessary. The PHA shall perform all inspections and tests in a manner that will not unnecessarily delay the work. Special, full size, and performance tests shall be performed as described in the contract.

- (f) The PHA may conduct routine inspections of the construction site on a daily basis.
- (g) The Contractor shall, without charge, replace or correct work found by the PHA not to conform to contract requirements, unless the PHA decides that it is in its interest to accept the work with an appropriate adjustment in contract price. The Contractor shall promptly segregate and remove rejected material from the premises.
- (h) If the Contractor does not promptly replace or correct rejected work, the PHA may (1) by contract or otherwise, replace or correct the work and charge the cost to the Contractor, or (2) terminate for default the Contractor's right to proceed.
- (i) If any work requiring inspection is covered up without approval of the PHA, it must, if requested by the Contracting Officer, be uncovered at the expense of the Contractor. If at any time before final acceptance of the entire work, the **Construction PHA** considers it necessary or advisable, to examine work already completed by removing or tearing it out, the Contractor, shall on request, promptly furnish all necessary facilities, labor, and material. If such work is found to be defective or nonconforming in any material respect due to the fault of the Contractor or its subcontractors, the Contractor shall defray all the expenses of the examination and of satisfactory reconstruction. If, however, such work is found to meet the requirements of the contract, the Contracting Officer shall make an equitable adjustment to cover the cost of the examination and reconstruction, including, if completion of the work was thereby delayed, an extension of time.
- (j) The Contractor shall notify the Contracting Officer, in writing, as to the date when in its opinion all or a designated portion of the work will be substantially completed and ready for inspection. If the Architect determines that the state of preparedness is as represented, the PHA will promptly arrange for the inspection. Unless otherwise specified in the contract, the PHA shall accept, as soon as practicable after completion and inspection, all work required by the contract or that portion of the work the Contracting Officer determines and designates can be accepted separately. Acceptance shall be final and conclusive except for latent defects, fraud, gross mistakes amounting to fraud, or the PHA's right under any warranty or guarantee.

21. Use and Possession Prior to Completion

- (a) The PHA shall have the right to take possession of or use any completed or partially completed part of the work. Before taking possession of or using any work, the Contracting Officer shall furnish the Contractor a list of items of work remaining to be performed or corrected on those portions of the work that the PHA intends to take possession of or use. However, failure of the Contracting Officer to list any item of work shall not relieve the Contractor of responsibility for complying with the terms of the contract. The PHA's possession or use shall not be deemed an acceptance of any work under the contract.
- (b) While the PHA has such possession or use, the Contractor shall be relieved of the responsibility for (1) the loss of or damage to the work resulting from the PHA's possession or use, notwithstanding the terms of the clause entitled Permits and Codes herein; (2) all maintenance costs on the areas occupied; and, (3) furnishing heat, light, power, and water used in the areas

occupied without proper remuneration therefore. If prior possession or use by the PHA delays the progress of the work or causes additional expense to the Contractor, an equitable adjustment shall be made in the contract price or the time of completion, and the contract shall be modified in writing accordingly.

22. Warranty of Title

The Contractor warrants good title to all materials, supplies, and equipment incorporated in the work and agrees to deliver the premises together with all improvements thereon free from any claims, liens or charges, and agrees further that neither it nor any other person, firm or corporation shall have any right to a lien upon the premises or anything appurtenant thereto.

23. Warranty of

- (a) In addition to any other warranties in this contract, the Contractor warrants, except as provided in paragraph (j) of this clause, that work performed under this contract conforms to the contract requirements and is free of any defect in equipment, material, or workmanship performed by the Contractor or any subcontractor or supplier at any tier. This warranty shall continue for a period of _____ (one year unless otherwise indicated) from the date of final acceptance of the work. If the PHA takes possession of any part of the work before final acceptance, this warranty shall continue for a period of (one year unless otherwise indicated) from the date that the PHA takes possession.
- (b) The Contractor shall remedy, at the Contractor's expense, any failure to conform, or any defect. In addition, the Contractor shall remedy, at the Contractor's expense, any damage to PHA-owned or controlled real or personal property when the damage is the result of—
 - (1) The Contractor's failure to conform to contract requirements; or
 - (2) Any defects of equipment, material, workmanship or design furnished by the Contractor.
- (c) The Contractor shall restore any work damaged in fulfilling the terms and conditions of this clause. The Contractor's warranty with respect to work repaired or replaced will run for (one year unless otherwise indicated) from the date of repair or replacement.
- (d) The Contracting Officer shall notify the Contractor, in writing, within a reasonable time after the discovery of any failure, defect or damage.
- (e) If the Contractor fails to remedy any failure, defect, or damage within a reasonable time after receipt of notice, the PHA shall have the right to replace, repair or otherwise remedy the failure, defect, or damage at the Contractor's expense.
- (f) With respect to all warranties, express or implied, from subcontractors, manufacturers, or suppliers for work performed and materials furnished under this contract, the Contractor shall:
 - (1) Obtain all warranties that would be given in normal commercial practice;
 - (2) Require all warranties to be executed in writing, for the benefit of the PHA; and,
 - (3) Enforce all warranties for the benefit of the PHA.
- (g) In the event the Contractor's warranty under paragraph (a) of this clause has expired, the PHA may bring suit at its own expense to enforce a subcontractor's, manufacturer's or supplier's warranty.

- (h) Unless a defect is caused by the negligence of the Contractor or subcontractor or supplier at any tier, the Contractor shall not be liable for the repair of any defect of material or design furnished by the PHA nor for the repair of any damage that results from any defect in PHA furnished material or design.
- (i) Notwithstanding any provisions herein to the contrary, the establishment of the time periods in paragraphs (a) and (c) above relate only to the specific obligation of the Contractor to correct the work, and have no relationship to the time within which its obligation to comply with the contract may be sought to be enforced, nor to the time within which proceedings may be commenced to establish the Contractor's liability with respect to its obligation other than specifically to correct the work.
- (j) This warranty shall not limit the PHA's rights under the Inspection and Acceptance of Construction clause of this contract with respect to latent defects, gross mistakes or fraud.

24. Prohibition Against Liens

The Contractor is prohibited from placing a lien on the PHA's property. This prohibition shall apply to all subcontractors at any tier and all materials suppliers.

Administrative Requirements

25. Contract Period

this contract within _____ calendar days of the effective date of the contract, or within the time schedule established in the notice to proceed issued by the Contracting Officer.

26. Order of Provisions

accordance with the terms and conditions of the

In the event of a conflict between these General Conditions and the Specifications, the General Conditions shall prevail. In the event of a conflict between the contract and any applicable state or local law or regulation, the state or local law or regulation shall prevail; provided that such state or local law or regulation does not conflict with, or is less restrictive than applicable federal law, regulation, or Executive Order. In the event of such a conflict, applicable federal law, regulation, and Executive Order shall prevail.

27. Payments

- (a) The PHA shall pay the Contractor the price as provided in this contract.
- (b) The PHA shall make progress payments approximately every 30 days as the work proceeds, on estimates of work accomplished which meets the standards of quality established under the contract, as approved by the Contracting Officer. The PHA may, subject to written determination and approval of the Contracting Officer, make more frequent payments to contractors which are qualified small businesses.
- (c) Before the first progress payment under this contract, the Contractor shall furnish, in such detail as requested by the Contracting Officer, a breakdown of the total contract price showing the amount included therein for each principal category of the work, which shall substantiate the payment amount requested in order to provide a

basis for determining progress payments. The breakdown shall be approved by the Contracting Officer and must be acceptable to HUD. If the contract covers more than one project, the Contractor shall furnish a separate breakdown for each. The values and quantities employed in making up this breakdown are for determining the amount of progress payments and shall not be construed as a basis for additions to or deductions from the contract price. The Contractor shall prorate its overhead and profit over the construction period of the contract.

- (d) The Contractor shall submit, on forms provided by the PHA, periodic estimates showing the value of the work performed during each period based upon the approved submitted not later than _____ days in advance of the date set for payment and are subject to correction and revision as required. The estimates must be approved by the Contracting Officer with the concurrence of the Architect prior to payment. If the contract covers more than one project, the Contractor shall furnish a separate progress payment estimate for each.
- (e) Along with each request for progress payments and the required estimates, the Contractor shall furnish the following certification, or payment shall not be made: I hereby certify, to the best of my knowledge and belief, that:

- (1) The amounts requested are only for performance in accordance with the specifications, terms, and conditions of the contract;
- (2) Payments to subcontractors and suppliers have been made from previous payments received under the contract, and timely payments will be made from the proceeds of the payment covered by this certification, in accordance with subcontract agreements; and,
- (3) This request for progress payments does not include any amounts which the prime contractor intends to withhold or retain from a subcontractor or supplier in subcontract.

Name:

Title:

Date:

- (f) Except as otherwise provided in State law, the PHA shall retain ten (10) percent of the amount of progress payments until completion and acceptance of all work under the contract; except, that if upon completion of 50 percent of the work, the Contracting Officer, after consulting with the Architect, determines that the Contractor's performance and progress are satisfactory, the PHA may make the remaining payments in full for the work subsequently completed. If the Contracting Officer subsequently determines that the Contractor's performance and progress are unsatisfactory, the PHA shall reinstate the ten (10) percent (or other percentage as provided in State law) retainage until such time as the Contracting Officer determines that performance and progress are satisfactory.
- (g) The Contracting Officer may authorize material delivered on the site and preparatory work done to be taken into consideration when computing progress payments.

Material delivered to the Contractor at locations other than the site may also be taken into consideration if the Contractor furnishes satisfactory evidence that (1) it has acquired title to such material; (2) the material is properly stored in a bonded warehouse, storage yard, or similar suitable place as may be approved by the Contracting Officer; (3) the material is insured to cover its full value; and (4) the material will be used to perform this contract. Before any progress payment which includes delivered material is made, the Contractor shall furnish such documentation as the Contracting Officer may require to assure the protection of the PHA's interest in such materials. The Contractor shall remain responsible for such stored material notwithstanding the transfer of title to the PHA.

- (h) All material and work covered by progress payments made shall, at the time of payment become the sole property of the PHA, but this shall not be construed as (1) relieving the Contractor from the sole responsibility for all material and work upon which payments have been made or the restoration of any damaged work; or, (2) waiving the right of the PHA to require the fulfillment of all of the terms of the contract. In the event the work of the Contractor has been damaged by other contractors or persons other than employees of the PHA in the course of their employment, the Contractor shall restore such damaged work without cost to the PHA and to seek redress for its damage only from those who directly caused it.
- (i) The PHA shall make the final payment due the Contractor under this contract after (1) completion and final acceptance of all work; and (2) presentation of release of all claims against the PHA arising by virtue of this contract, other than claims, in stated amounts, that the Contractor has specifically excepted from the operation of the release. Each such exception shall embrace no more than one claim, the basis and scope of which shall be clearly defined. The amounts for such excepted claims shall not be included in the request for final payment. A release may also be required of the assignee if the Contractor's claim to amounts payable under this contract has been assigned.
- (j) Prior to making any payment, the Contracting Officer may require the Contractor to furnish receipts or other evidence of payment from all persons performing work and supplying material to the Contractor, if the Contracting Officer determines such evidence is necessary to substantiate claimed costs.
- (k) The PHA shall not; (1) determine or adjust any claims for payment or disputes arising there under between the Contractor and its subcontractors or material suppliers; or, (2) withhold any moneys for the protection of the subcontractors or material suppliers. The failure or refusal of the PHA to withhold moneys from the Contractor shall in nowise impair the obligations of any surety or sureties under any bonds furnished under this contract.

28. Contract Modifications

- (a) Only the Contracting Officer has authority to modify any term or condition of this contract. Any contract modification shall be authorized in writing.
- (b) The Contracting Officer may modify the contract unilaterally (1) pursuant to a specific authorization stated in a contract clause (e.g., Changes); or (2) for administrative matters which do not change the rights or

responsibilities of the parties (e.g., change in the PHA address). All other contract modifications shall be in the form of supplemental agreements signed by the Contractor and the Contracting Officer.

- (c) When a proposed modification requires the approval of HUD prior to its issuance (e.g., a change order that exceeds the PHA's approved threshold), such modification shall not be effective until the required approval is received by the PHA.

29. Changes

- (a) The Contracting Officer may, at any time, without notice to the sureties, by written order designated or indicated to be a change order, make changes in the work within the general scope of the contract including changes:
 - (1) In the specifications (including drawings and designs);
 - (2) In the method or manner of performance of the work;
 - (3) PHA-furnished facilities, equipment, materials, services, or site; or,
 - (4) Directing the acceleration in the performance of the work.
- (b) Any other written order or oral order (which, as used in this paragraph (b), includes direction, instruction, interpretation, or determination) from the Contracting Officer that causes a change shall be treated as a change order under this clause; provided, that the Contractor gives the Contracting Officer written notice stating (1) the date, circumstances and source of the order and (2) that the Contractor regards the order as a change order.
- (c) Except as provided in this clause, no order, statement or conduct of the Contracting Officer shall be treated as a change under this clause or entitle the Contractor to an equitable adjustment.
- (d) If any change under this clause causes an increase or decrease in the Contractor's cost of, or the time required for the performance of any part of the work under this contract, whether or not changed by any such order, the Contracting Officer shall make an equitable adjustment and modify the contract in writing. However, except for an adjustment based on defective specifications, no proposal for any change under paragraph (b) above shall be allowed for any costs incurred more than 20 days (5 days for oral orders) before the Contractor gives written notice as required. In the case of defective specifications for which the PHA is responsible, the equitable adjustment shall include any increased cost reasonably incurred by the Contractor in attempting to comply with the defective specifications.
- (e) The Contractor must assert its right to an adjustment under this clause within 30 days after (1) receipt of a written change order under paragraph (a) of this clause, or (2) the furnishing of a written notice under paragraph (b) of this clause, by submitting a written statement describing the general nature and the amount of the proposal. If the facts justify it, the Contracting Officer may extend the period for submission. The proposal may be included in the notice required under paragraph (b) above. No proposal by the Contractor for an equitable adjustment shall be allowed if asserted after final payment under this contract.
- (f) The Contractor's written proposal for equitable adjustment shall be submitted in the form of a lump sum proposal supported with an itemized breakdown of all increases and decreases in the contract in at least the following details:

- (1) Direct Costs. Materials (list individual items, the quantity and unit cost of each, and the aggregate cost); Transportation and delivery costs associated with materials; Labor breakdowns by hours or unit costs (identified with specific work to be performed); Construction equipment exclusively necessary for the change; Costs of preparation and/ or revision to shop drawings resulting from the change; Worker's Compensation and Public Liability Insurance; Employment taxes under FICA and FUTA; and, Bond Costs when size of change warrants revision.
- (2) Indirect Costs. Indirect costs may include overhead, general and administrative expenses, and fringe benefits not normally treated as direct costs.
- (3) Profit. The amount of profit shall be negotiated and may vary according to the nature, extent, and complexity of the work required by the change. The allowability of the direct and indirect costs shall be determined in accordance with the Contract Cost Principles and Procedures for Commercial Firms in Part 31 of the Federal Acquisition Regulation (48 CFR 1-31), as implemented by HUD Handbook 2210.18, in effect on the date of this contract. The Contractor shall not be allowed a profit on the profit received by any subcontractor. Equitable adjustments for deleted work shall include a credit for profit and may include a credit for indirect costs. On proposals covering both increases and decreases in the amount of the contract, the application of indirect costs and profit shall be on the net-change in direct costs for the Contractor or subcontractor performing the work.
- (g) The Contractor shall include in the proposal its request for time extension (if any), and shall include sufficient information and dates to demonstrate whether and to what extent the change will delay the completion of the contract in its entirety.
- (h) The Contracting Officer shall act on proposals within 30 days after their receipt, or notify the Contractor of the date when such action will be taken.
- (i) Failure to reach an agreement on any proposal shall be a dispute under the clause entitled Disputes herein. Nothing in this clause, however, shall excuse the Contractor from proceeding with the contract as changed.
- (j) Except in an emergency endangering life or property, no change shall be made by the Contractor without a prior order from the Contracting Officer.

30. Suspension of Work

- (a) The Contracting Officer may order the Contractor in writing to suspend, delay, or interrupt all or any part of the work of this contract for the period of time that the Contracting Officer determines appropriate for the convenience of the PHA.
- (b) If the performance of all or any part of the work is, for an unreasonable period of time, suspended, delayed, or interrupted (1) by an act of the Contracting Officer in the administration of this contract, or (2) by the Contracting Officer's failure to act within the time specified (or within a reasonable time if not specified) in this contract an adjustment shall be made for any increase in the cost of performance of the contract (excluding profit) necessarily caused by such unreasonable suspension, delay, or interruption and the contract modified in writing accordingly. However, no adjustment shall be made under this clause for any suspension, delay, or interruption to the extent that performance would have

- been so suspended, delayed, or interrupted by any other cause, including the fault or negligence of the Contractor or for which any equitable adjustment is provided for or excluded under any other provision of this contract.
- (c) A claim under this clause shall not be allowed (1) for any costs incurred more than 20 days before the Contractor shall have notified the Contracting Officer in writing of the act or failure to act involved (but this requirement shall not apply as to a claim resulting from a suspension order); and, (2) unless the claim, in an amount stated, is asserted in writing as soon as practicable after the termination of the suspension, delay, or interruption, but not later than the date of final payment under the contract.

31. Disputes

- (a) "Claim," as used in this clause, means a written demand or written assertion by one of the contracting parties seeking, as a matter of right, the payment of money in a sum certain, the adjustment or interpretation of contract terms, or other relief arising under or relating to the contract. A claim arising under the contract, unlike a claim relating to the contract, is a claim that can be resolved under a contract clause that provides for the relief sought by the claimant. A voucher, invoice, or other routine request for payment that is not in dispute when submitted is not a claim. The submission may be converted to a claim by complying with the requirements of this clause, if it is disputed either as to liability or amount or is not acted upon in a reasonable time.
- (b) Except for disputes arising under the clauses entitled Labor Standards - Davis Bacon and Related Acts, herein, all disputes arising under or relating to this contract, including any claims for damages for the alleged breach thereof which are not disposed of by agreement, shall be resolved under this clause.
- (c) All claims by the Contractor shall be made in writing and submitted to the Contracting Officer for a written decision. A claim by the PHA against the Contractor shall be subject to a written decision by the Contracting Officer.
- (d) The Contracting Officer shall, within 60 (unless otherwise indicated) days after receipt of the request, decide the claim or notify the Contractor of the date by which the decision will be made.
- (e) The Contracting Officer's decision shall be final unless the Contractor (1) appeals in writing to a higher level in the PHA in accordance with the PHA's policy and procedures, (2) refers the appeal to an independent mediator or arbitrator, or (3) files suit in a court of competent jurisdiction. Such appeal must be made within (30 unless otherwise indicated) days after receipt of the Contracting Officer's decision.
- (f) The Contractor shall proceed diligently with performance of this contract, pending final resolution of any request for relief, claim, appeal, or action arising under or relating to the contract, and comply with any decision of the Contracting Officer.

32. Default

- (a) If the Contractor refuses or fails to prosecute the work, or any separable part thereof, with the diligence that will insure its completion within the time specified in this contract, or any extension thereof, or fails to complete said work within this time, the Contracting Officer may, by written notice to the Contractor, terminate the right to

proceed with the work (or separable part of the work) that has been delayed. In this event, the PHA may take over the work and complete it, by contract or otherwise, and may take possession of and use any materials, equipment, and plant on the work site necessary for completing the work. The Contractor and its sureties shall be liable for any damage to the PHA resulting from the **Convenience** Contractor's refusal or failure to complete the work within the specified time, whether or not the Contractor's right to proceed with the work is terminated. This liability includes any increased costs incurred by the PHA in completing the work.

- (b) The Contractor's right to proceed shall not be terminated or the Contractor charged with damages under this clause if—
- (1) The delay in completing the work arises from unforeseeable causes beyond the control and without the fault or negligence of the Contractor. Examples of such causes include (i) acts of God, or of the public enemy, (ii) acts of the PHA or other governmental entity in either its sovereign or contractual capacity, (iii) acts of another contractor in the performance of a contract with the PHA, (iv) fires, (v) floods, (vi) epidemics, (vii) quarantine restrictions, (viii) strikes, (ix) freight embargoes, (x) unusually severe weather, or (xi) delays of subcontractors or suppliers at any tier arising from unforeseeable causes beyond the control and without the fault or negligence of both the Contractor and the subcontractors or suppliers; and
 - (2) The Contractor, within days (10 days unless otherwise indicated) from the beginning of such delay (unless extended by the Contracting Officer) notifies the Contracting Officer in writing of the causes of delay. The Contracting Officer shall ascertain the facts and the extent of the delay. If, in the judgment of the Contracting Officer, the findings of fact warrant such action, time for completing the work shall be extended by written modification to the contract. The findings of the Contracting Officer shall be reduced to a written decision which shall be subject to the provisions of the Disputes clause of this contract.
- (c) If, after termination of the Contractor's right to proceed, it is determined that the Contractor was not in default, or that the delay was excusable, the rights and obligations of the parties will be the same as if the termination had been for convenience of the PHA.

33. Liquidated Damages

- (a) If the Contractor fails to complete the work within the time specified in the contract, or any extension, as specified in the clause entitled Default of this contract, the Contractor shall pay to the PHA as liquidated damages, the sum of \$ _____ [Contracting Officer insert amount] for each day of delay. If different completion dates are specified in the contract for separate parts or stages of the work, the amount of liquidated damages shall be assessed on those parts or stages which are delayed. To the extent that the Contractor's delay or nonperformance is excused under another clause in this contract, liquidated damages shall not be due the PHA. The Contractor remains liable for damages caused other than by delay.
- (b) If the PHA terminates the Contractor's right to proceed, the resulting damage will consist of liquidated damages until such reasonable time as may be required for final

completion of the work together with any increased costs occasioned the PHA in completing the work.

- (c) If the PHA does not terminate the Contractor's right to proceed, the resulting damage will consist of liquidated damages until the work is completed or accepted.

34. Termination for

- (a) The Contracting Officer may terminate this contract in whole, or in part, whenever the Contracting Officer determines that such termination is in the best interest of the PHA. Any such termination shall be effected by delivery to the Contractor of a Notice of Termination specifying the extent to which the performance of the work under the contract is terminated, and the date upon which such termination becomes effective.
- (b) If the performance of the work is terminated, either in whole or in part, the PHA shall be liable to the Contractor for reasonable and proper costs resulting from such termination upon the receipt by the PHA of a properly presented claim setting out in detail: (1) the total cost of the work performed to date of termination less the total amount of contract payments made to the Contractor; (2) the cost (including reasonable profit) of settling and paying claims under subcontracts and material orders for work performed and materials and supplies delivered to the site, payment for which has not been made by the PHA to the Contractor or by the Contractor to the subcontractor or supplier; (3) the cost of preserving and protecting the work already performed until the PHA or assignee takes possession thereof or assumes responsibility therefore; (4) the actual or estimated cost of legal and accounting services reasonably necessary to prepare and present the termination claim to the PHA; and (5) an amount constituting a reasonable profit on the value of the work performed by the Contractor.
- (c) The Contracting Officer will act on the Contractor's claim within days (60 days unless otherwise indicated) of receipt of the Contractor's claim.
- (d) Any disputes with regard to this clause are expressly made subject to the provisions of the Disputes clause of this contract.

35. Assignment of Contract

The Contractor shall not assign or transfer any interest in this contract; except that claims for monies due or to become due from the PHA under the contract may be assigned to a bank, trust company, or other financial institution. Such assignments of claims shall only be made with the written concurrence of the Contracting Officer. If the Contractor is a partnership, this contract shall inure to the benefit of the surviving or remaining member(s) of such partnership as approved by the Contracting Officer.

36. Insurance

- (a) Before commencing work, the Contractor and each subcontractor shall furnish the PHA with certificates of insurance showing the following insurance is in force and will insure all operations under the Contract:
 - (1) Workers' Compensation, in accordance with state or Territorial Workers' Compensation laws.
 - (2) Commercial General Liability with a combined single limit for bodily injury and property damage of not less than \$ _____ [Contracting Officer insert amount]

per occurrence to protect the Contractor and each subcontractor against claims for bodily injury or death and damage to the property of others. This shall cover the use of all equipment, hoists, and vehicles on the site(s) not covered by Automobile Liability under (3) below. If the Contractor has a "claims made" policy, then the following additional requirements apply: the policy must provide a "retroactive date" which must be on or before the execution date of the Contract; and the extended reporting period may not be less than five years following the completion date of the Contract.

- (3) Automobile Liability on owned and non-owned motor vehicles used on the site(s) or in connection therewith for a combined single limit for bodily injury and property damage of not less than \$ _____

[Contracting Officer insert amount] per occurrence.

- (b) Before commencing work, the Contractor shall furnish the PHA with a certificate of insurance evidencing that Builder's Risk (fire and extended coverage) Insurance on all work in place and/or materials stored at the building site(s), including foundations and building equipment, is in force. The Builder's Risk Insurance shall be for the benefit of the Contractor and the PHA as their interests may appear and each shall be named in the policy or policies as an insured. The Contractor in installing equipment supplied by the PHA shall carry insurance on such equipment from the time the Contractor takes possession thereof until the Contract work is accepted by the PHA. The Builder's Risk Insurance need not be carried on excavations, piers, footings, or foundations until such time as work on the superstructure is started. It need not be carried on landscape work. Policies shall furnish coverage at all times for the full cash value of all completed construction, as well as materials in place and/or stored at the site(s), whether or not partial payment has been made by the PHA. The Contractor may terminate this insurance on buildings as of the date taken over for occupancy by the PHA. The Contractor is not required to carry Builder's Risk Insurance for modernization work which does not involve structural alterations or additions and where the PHA's existing fire and extended coverage policy can be endorsed to include such work.
- (c) All insurance shall be carried with companies which are financially responsible and admitted to do business in the State in which the project is located. If any such insurance is due to expire during the construction period, the Contractor (including subcontractors, as applicable) shall not permit the coverage to lapse and shall furnish evidence of coverage to the Contracting Officer. All certificates of insurance, as evidence of coverage, shall provide that no coverage may be canceled or non-renewed by the insurance company until at least 30 days prior written notice has been given to the Contracting Officer.

37. Subcontracts

- (a) Definitions. As used in this contract -
- (1) "Subcontract" means any contract, purchase order, or other purchase agreement, including modifications and change orders to the foregoing, entered into by a subcontractor to furnish supplies, materials, equipment, and services for the performance of the prime contract or a subcontract.

- (2) "Subcontractor" means any supplier, vendor, or firm that furnishes supplies, materials, equipment, or services to or for the Contractor or another subcontractor.
- (b) The Contractor shall not enter into any subcontract with any subcontractor who has been temporarily denied participation in a HUD program or who has been suspended or debarred from participating in contracting programs by any agency of the United States Government or of the state in which the work under this contract is to be performed.
- (c) The Contractor shall be as fully responsible for the acts or omissions of its subcontractors, and of persons either directly or indirectly employed by them as for the acts or omissions of persons directly employed by the Contractor.
- (d) The Contractor shall insert appropriate clauses in all subcontracts to bind subcontractors to the terms and conditions of this contract insofar as they are applicable to the work of subcontractors.
- (e) Nothing contained in this contract shall create any contractual relationship between any subcontractor and the PHA or between the subcontractor and HUD.

38. Subcontracting with Small and Minority Firms, Women's Business Enterprise, and Labor Surplus Area Firms

The Contractor shall take the following steps to ensure that, whenever possible, subcontracts are awarded to small business firms, minority firms, women's business enterprises, and labor surplus area firms:

- (a) Placing qualified small and minority businesses and women's business enterprises on solicitation lists;
- (b) Ensuring that small and minority businesses and women's business enterprises are solicited whenever they are potential sources;
- (c) Dividing total requirements, when economically feasible, into smaller tasks or quantities to permit maximum participation by small and minority businesses and women's business enterprises;
- (d) Establishing delivery schedules, where the requirements of the contract permit, which encourage participation by small and minority businesses and women's business enterprises; and
- (e) Using the services and assistance of the U.S. Small Business Administration, the Minority Business Development Agency of the U.S. Department of Commerce, and State and local governmental small business agencies.

39. Equal Employment Opportunity

During the performance of this contract, the Contractor/Seller agrees as follows:

- (a) The Contractor/Seller shall not discriminate against any employee or applicant for employment because of race color, religion, sex, sexual orientation, gender identity, disability, or national origin.
- (b) The Contractor/Seller shall take affirmative action to ensure that applicants are employed, and that employees are treated during employment without regard to their race, color, religion, sex, sexual orientation, gender identity, disability, or national origin. Such action shall include, but not be limited to, (1) employment, (2) upgrading demotion, (4) transfer, (5) recruitment or recruitment advertising, (6) layoff or termination, (7) rates of pay or other forms of compensation, and (8) selection for training, including apprenticeship

(c) The Contractor/Seller agrees to post in conspicuous places available to employees and applicants for employment the notices to be provided by the Contracting Officer setting forth the provisions of this nondiscrimination clause.

(d) The Contractor/Seller shall, in all solicitations or advertisements for employees placed by or on behalf of the Contractor/Seller, state that all qualified applicants will receive consideration for employment without regard to race, color, religion, sex, or national origin.

(e) The Contractor/Seller shall send, to each labor union or representative of workers with which it has a collective bargaining agreement or other contract or understanding, the notice to be provided by the Contracting Officer advising the labor union or workers' representative of the Contractor's commitments under this clause, and post copies of the notice in conspicuous places available to employees and applicants for employment.

(f) The Contractor/Seller shall comply with Executive Order 11246, as amended, and the rules, regulations, and orders of the Secretary of Labor.

(g) The Contractor/Seller shall furnish all information and reports required by Executive Order 11246, as amended, Section 503 of the Rehabilitation Act of 1973, as amended, and by rules, regulations, and orders of the Secretary of Labor, or pursuant thereto. The Contractor/Seller shall permit

access to its books, records, and accounts by the Secretary of Labor for purposes of investigation to ascertain compliance with such rules, regulations, and orders.

(h) In the event of a that the Contractor/Seller is in noncompliance with the nondiscrimination clauses of this contract or with any of such rules, regulations, or orders, this contract may be canceled, terminated or suspended in whole or in part and the contractor/seller may be declared ineligible for further Government contracts in accordance with procedures authorized in Executive Order 11246 of September 24, 1965, and such other sanctions may be imposed and remedies invoked as provided in Executive Order 11246 of September 24, 1965, or by rule, regulation, or order of the Secretary of Labor, or as otherwise provided by law.

(i) The contractor/seller will include the provisions of paragraphs (a) through (h) in every subcontract or purchase order unless exempted by rules, regulations, or orders of the Secretary of Labor issued pursuant to section 204 of Executive Order 11246 of September 24, 1965, so that such provisions will be binding upon each sub[contractor/seller] or vendor. The [contractor/seller] will take such action with respect to any subcontract or purchase order as may be directed by the Secretary of Labor as a means of enforcing such provisions including sanctions for noncompliance: Provided, however, that in the event the [contractor/seller] becomes involved in, or is threatened with, litigation with a subcontractor or vendor as a result of such direction, the [contractor/seller] may request the United States to enter into such litigation to protect the interests of the United States.

(j) Compliance with the requirements of this clause shall be to the maximum extent consistent with, but not in derogation of, compliance with section 7(b) of the Indian Self-Determination and Education Assistance Act and the Indian Preference clause of this contract.

40. Employment, Training, and Contracting Opportunities for Low-Income Persons, Section 3 of the Housing and Urban Development Act of 1968.

(a) The work to be performed under this contract is subject to the requirements of Section 3 of the Housing and Urban Development Act of 1968, as amended, 12 U.S.C. 1701u (section 3). The purpose of section 3 is to ensure that employment and other economic opportunities generated by HUD assistance or HUD-assisted projects covered by Section 3, shall, to the greatest extent feasible, be directed to low- and very low-income persons, particularly persons who are recipients of HUD assistance for housing.

(b) The parties to this contract agree to comply with HUD's regulations in 24 CFR Part 75, which implement Section 3. As evidenced by their execution of this contract, the parties to this contract certify that they are under no contractual or other impediment that would prevent them from complying with the Part 75 regulations.

(c) The contractor agrees to send to each labor organization or representative of workers with which the contractor has a collective bargaining agreement or other understanding, if any, a notice advising the labor organization or workers' representative of the contractor's commitments under this section 3 clause and will post copies of the notice in conspicuous places at the work site where both employees and applicants for training and employment positions can see the notice. The notice shall describe the Section 3 prioritization requirements and shall state the minimum percentages of labor hour requirements established in the Benchmark Notice (FR-6085-N-04).

(d) The contractor agrees to include this section 3 clause in every subcontract subject to compliance with regulations in 24 CFR Part 75, and agrees to take appropriate action, as provided in an applicable provision of the subcontract or in this section 3 clause, upon a finding that the subcontractor is in violation of the regulations in 24 CFR Part 75. The contractor will not subcontract with any subcontractor where the contractor has notice or knowledge that the subcontractor has been found in violation of the regulations in 24 CFR Part 75.

(e) Noncompliance with HUD's regulations in 24 CFR Part 75 may result in sanctions, termination of this contract for default, and debarment or suspension from future HUD assisted contracts.

(f) Contracts, subcontracts, grants, or subgrants subject to Section 7(b) of the Indian Self-Determination and Education Assistance Act (25 U.S.C. 5307(b)) or subject to tribal preference requirements as authorized under 101(k) of the Native American Housing Assistance and Self-Determination Act (25 U.S.C. 4111(k)) must provide preferences in employment, training, and business opportunities to Indians and Indian organizations, and are therefore not subject to the requirements of 24 CFR Part 75.

41. Interest of Members of Congress

No member of or delegate to the Congress of the United States of America shall be admitted to any share or part of this contract or to any benefit that may arise therefrom.

42. Interest of Members, Officers, or Employees and Former Members, Officers, or Employees

No member, officer, or employee of the PHA, no member of the governing body of the locality in which the project is situated, no member of the governing body of the locality in which the PHA was activated, and no other public official of such locality or localities who exercises any functions or responsibilities with respect to the project, shall, during his or her tenure, or for one year thereafter, have any interest, direct or indirect, in this contract or the proceeds thereof.

43. Limitations on Payments made to Influence Certain Federal Financial Transactions

- (a) The Contractor agrees to comply with Section 1352 of Title 31, United States Code which prohibits the use of **Acts** Federal appropriated funds to pay any person for influencing or attempting to influence an officer or employee of any agency, a Member of Congress, and officer or employee of Congress, or an employee of a Member of Congress in connection with any of the following covered Federal actions: the awarding of any Federal contract; the making of any Federal grant; the making of any Federal loan; the entering into of any cooperative agreement; or the modification of any Federal contract, grant, loan, or cooperative agreement.
- (b) The Contractor further agrees to comply with the requirement of the Act to furnish a disclosure (OMB Standard Form LLL, Disclosure of Lobbying Activities) if any funds other than Federal appropriated funds (including profit or fee received under a covered Federal transaction) have been paid, or will be paid, to any person for influencing or attempting to influence an officer or employee of any agency, a Member of Congress, an officer or employee of Congress, or an employee of a Member of Congress in connection with a Federal contract, grant, loan, or cooperative agreement.

44. Royalties and Patents

The Contractor shall pay all royalties and license fees. It shall defend all suits or claims for infringement of any patent rights and shall save the PHA harmless from loss on account thereof; except that the PHA shall be responsible for all such loss when a particular design, process or the product of a particular manufacturer or manufacturers is specified and the Contractor has no reason to believe that the specified design, process, or product is an infringement. If, however, the Contractor has reason to believe that any design, process or product specified is an infringement of a patent, the Contractor shall promptly notify the Contracting Officer. Failure to give such notice shall make the Contractor responsible for resultant loss.

45. Examination and Retention of Contractor's Records

- (a) The PHA, HUD, or Comptroller General of the United States, or any of their duly authorized representatives shall, until 3 years after final payment under this contract, have access to and the right to examine any of the Contractor's directly pertinent books, documents, papers, or other records involving transactions related to this contract for the purpose of making audit, examination, excerpts, and transcriptions.
- (b) The Contractor agrees to include in first-tier subcontracts under this contract a clause substantially the same as paragraph (a) above. "Subcontract," as used in this clause, excludes purchase orders not exceeding \$10,000.
- (c) The periods of access and examination in paragraphs (a) and (b) above for records relating to (1) appeals under the Disputes clause of this contract, (2) litigation or settlement of claims arising from the performance of this contract, or (3) costs and expenses of this contract to which the PHA, HUD, or Comptroller General or any of their duly authorized representatives has taken exception shall continue until disposition of such appeals, litigation, claims, or exceptions.

46. Labor Standards - Davis-Bacon and Related

If the total amount of this contract exceeds \$2,000, the Federal labor standards set forth in the clause below shall apply to the development or construction work to be performed under the contract.

- (a) Minimum Wages.
 - (1) All laborers and mechanics employed under this contract in the development or construction of the project(s) involved will be paid unconditionally and not less often than once a week, and without subsequent deduction or rebate on any account (except such payroll deductions as are permitted by regulations issued by the Secretary of Labor under the Copeland Act (29 CFR Part 3)), the full amount of wages and bona fide fringe benefits (or cash equivalents thereof) due at time of payment computed at rates not less than those contained in the wage determination of the Secretary of Labor which is attached hereto and made a part hereof, regardless of any contractual relationship which may be alleged to exist between the Contractor and such laborers and mechanics. Contributions made or costs reasonably anticipated for bona fide fringe benefits under Section 1(b)(2) of the Davis-Bacon Act on behalf of laborers or mechanics are considered wages paid to such laborers or mechanics, subject to the provisions of 29 CFR 5.5(a)(1)(iv); also, regular contributions made or costs incurred for more than a weekly period (but not less often than quarterly) under plans, funds, or programs which cover the regular weekly period, are deemed to be constructively made or incurred during such weekly period. Such laborers and mechanics shall be paid the appropriate wage rate and fringe benefits in the wage determination for the classification of work actually performed, without regard to skill, except as provided in 29 CFR 5.5(a)(4). Laborers or mechanics performing work in more than one classification may be compensated at the rate specified for each classification for the time actually worked therein; provided, that the employer's payroll records accurately set forth the time spent in each classification in which work is performed. The wage determination (including any additional classification and wage rates conformed under 29 CFR 5.5(a)(1)(ii) and the Davis-Bacon poster (WH-1321) shall

be posted at all times by the Contractor and its subcontractors at the site of the work in a prominent and accessible place where it can be easily seen by the workers.

(2) (i) Any class of laborers or mechanics, including

helpers, which is not listed in the wage determination and which is to be employed under the contract shall be classified in conformance with the wage determination. HUD shall approve an additional classification and wage rate and fringe benefits therefor only when all the following criteria have been met: (A) The work to be performed by the classification requested is not performed by a classification in the wage determination; and (B) The classification is utilized in the area by the construction industry; and (C) The proposed wage rate, including any bona fide fringe benefits, bears a reasonable relationship to the wage rates contained in the wage determination.

- (ii) If the Contractor and the laborers and mechanics to be employed in the classification (if known), or their representatives, and HUD or its designee agree on the classification and wage rate (including the amount designated for fringe benefits where appropriate), a report of the action taken shall be sent by HUD or its designee to the Administrator of the Wage and Hour Division, Employee Standards Administration, U.S. Department of Labor, Washington, DC 20210. The Administrator, or an authorized representative, will approve, modify, or disapprove every additional classification action within 30 days of receipt and so advise HUD or its designee or will notify HUD or its designee within the 30-day period that additional time is necessary.
- (iii) In the event the Contractor, the laborers or mechanics to be employed in the classification or their representatives, and HUD or its designee do not agree on the proposed classification and wage rate (including the amount designated for fringe benefits, where appropriate), HUD or its designee shall refer the questions, including the views of all interested parties and the recommendation of HUD or its designee, to the Administrator of the Wage and Hour Division for determination. The Administrator, or an authorized representative, will issue a determination within 30 days of receipt and so advise HUD or its designee or will notify HUD or its designee within the 30-day period that additional time is necessary.
- (iv) The wage rate (including fringe benefits where appropriate) determined pursuant to subparagraphs (a)(2)(ii) or (iii) of this clause shall be paid to all workers performing work in the classification under this contract from the first day on which work is performed in classification.
- (3) Whenever the minimum wage rate prescribed in the contract for a class of laborers or mechanics includes a fringe benefit which is not expressed as an hourly rate, the Contractor shall either pay the benefit as stated in the wage determination or shall pay another bona fide fringe benefit or an hourly cash equivalent thereof.
- (4) If the Contractor does not make payments to a trustee or other third person, the Contractor may consider as part of the wages of any laborer or mechanic the

amount of any costs reasonably anticipated in providing bona fide fringe benefits under a plan or program; provided, that the Secretary of Labor has found, upon the written request of the Contractor, that the applicable standards of the Davis-Bacon Act have been met. The Secretary of Labor may require the Contractor to set aside in a separate account assets for the meeting of obligations under the plan or program.

- (b) Withholding of funds. HUD or its designee shall, upon its own action or upon written request of an authorized representative of the Department of Labor, withhold or cause to be withheld from the Contractor under this contract or any other Federal contract with the same prime Contractor, or any other Federally-assisted contract subject to Davis-Bacon prevailing wage requirements, which is held by the same prime Contractor, so much of the accrued payments or advances as may be considered necessary to pay laborers and mechanics, including apprentices, trainees, and helpers, employed by the Contractor or any subcontractor the full amount of wages required by the contract. In the event of failure to pay any laborer or mechanic, including any apprentice, trainee, or helper, employed or working in the construction or development of the project, all or part of the wages required by the contract, HUD or its designee may, after written notice to the Contractor, take such action as may be necessary to cause the suspension of any further payment, advance, or guarantee of funds until such violations have ceased. HUD or its designee may, after written notice to the Contractor, disburse such amounts withheld for and on account of the Contractor or subcontractor to the respective employees to whom they are due.
- (c) Payrolls and basic records.
- (1) Payrolls and basic records relating thereto shall be maintained by the Contractor during the course of the work and preserved for a period of three years thereafter for all laborers and mechanics working in the construction or development of the project. Such records shall contain the name, address, and social security number of each such worker, his or her correct classification, hourly rates of wages paid (including rates of contributions or costs anticipated for bona fide fringe benefits or cash equivalents thereof of the types described in section 1(b)(2)(B) of the Davis-Bacon Act), daily and weekly number of hours worked, deductions made, and actual wages paid. Whenever the Secretary of Labor has found, under 29 CFR 5.5(a)(1)(iv), that the wages of any laborer or mechanic include the amount of costs reasonably anticipated in providing benefits under a plan or program described in section 1(b)(2)(B) of the Davis-Bacon Act, the Contractor shall maintain records which show that the commitment to provide such benefits is enforceable, that the plan or program is financially responsible, and that the plan or program has been communicated in writing to the laborers or mechanics affected, and records which show the costs anticipated or the actual cost incurred in providing such benefits. Contractors employing apprentices or trainees under approved programs shall maintain written evidence of the registration of apprenticeship programs and certification of trainee programs, the registration of the apprentices and trainees, and the ratios and wage rates prescribed in the applicable programs.

(2) (i) The Contractor shall submit weekly for each week in which any contract work is performed a copy of all payrolls to the Contracting Officer for transmission to HUD or its designee. The payrolls submitted shall set out accurately and completely all of the information required to be maintained under subparagraph (c)(1) of this clause. This information may be submitted in any form desired. Optional Form WH-347 (Federal Stock Number 029-005-00014-1) is available for this purpose and may be purchased from the Superintendent of Documents, U.S. Government Printing Office, Washington, D.C. 20402. The Contractor is responsible for the submission of copies of payrolls by all subcontractors. (Approved by the Office of Management and Budget under OMB Control Number 1214-0149.)

(ii) Each payroll submitted shall be accompanied by a "Statement of Compliance," signed by the Contractor or subcontractor or his or her agent who pays or supervises the payment of the persons employed under the contract and shall certify the following:

- (A) That the payroll for the payroll period contains the information required to be maintained under paragraph (c) (1) of this clause and that such information is correct and complete;
 - (B) That each laborer or mechanic (including each helper, apprentice, and trainee) employed on the contract during the payroll period has been paid the full weekly wages earned, without rebate, either directly or indirectly, and that no deductions have been made either directly or indirectly from the full wages earned, other than permissible deductions as set forth in 29 CFR Part 3; and
 - (C) That each laborer or mechanic has been paid not less than the applicable wage rates and fringe benefits or cash equivalents for the classification of work performed, as specified in the applicable wage determination incorporated into the contract.
- (iii) The weekly submission of a properly executed certification set forth on the reverse side of Optional Form WH-347 shall satisfy the requirements for submission of the "Statement of Compliance" required by subparagraph (c)(2)(ii) of this clause.
- (iv) The falsification of any of the above certifications may subject the Contractor or subcontractor to civil or criminal prosecution under Section 1001 of Title 18 and Section 3729 of Title 31 of the United States Code.

(3) The Contractor or subcontractor shall make the records required under subparagraph (c)(1) available for inspection, copying, or transcription by authorized representatives of HUD or its designee, the Contracting Officer, or the Department of Labor and shall permit such representatives to interview employees during working hours on the job. If the Contractor or subcontractor fails to submit the required records or to make them available, HUD or its designee may, after written notice to the Contractor, take such action as may be necessary to cause the suspension of any further payment, advance, or guarantee of funds. Furthermore, failure to submit the required records upon request or to

make such records available may be grounds for debarment action pursuant to 29 CFR 5.12.

- (d) (1) Apprentices. Apprentices will be permitted to work at less than the predetermined rate for the work they performed when they are employed pursuant to and individually registered in a bona fide apprenticeship program registered with the U.S. Department of Labor, Employment and Training Administration, Office of Apprenticeship and Training, Employer and Labor Services (OATELS), or with a State Apprenticeship Agency recognized by OATELS, or if a person is employed in his or her first 90 days of probationary employment as an apprentice in such an apprenticeship program, who is not individually registered in the program, but who has been certified by OATELS or a State Apprenticeship Agency (where appropriate) to be eligible for probationary employment as an apprentice. The allowable ratio of apprentices to journeymen on the job site in any craft classification shall not be greater than the ratio permitted to the Contractor as to the entire work force under the registered program. Any worker listed on a payroll at an apprentice wage rate, who is not registered or otherwise employed as stated in this paragraph, shall be paid not less than the applicable wage rate on the wage determination for the classification of work actually performed. In addition, any apprentice performing work on the job site in excess of the ratio permitted under the registered program shall be paid not less than the applicable wage rate on the wage determination for the work actually performed. Where a contractor is performing construction on a project in a locality other than that in which its program is registered, the ratios and wage rates (expressed in percentages of the journeyman's hourly rate) specified in the Contractor's or subcontractor's registered program shall be observed. Every apprentice must be paid at not less than the rate specified in the registered program for the apprentice's level of progress, expressed as a percentage of the journeyman hourly rate specified in the applicable wage determination. Apprentices shall be paid fringe benefits in accordance with the provisions of the apprenticeship program. If the apprenticeship program does not specify fringe benefits, apprentices must be paid the full amount of fringe benefits listed on the wage determination for the applicable classification. If the Administrator of the Wage and Hour Division determines that a different practice prevails for the applicable apprentice classification, fringes shall be paid in accordance with that determination. In the event OATELS, or a State Apprenticeship Agency recognized by OATELS, withdraws approval of an apprenticeship program, the Contractor will no longer be permitted to utilize apprentices at less than the applicable predetermined rate for the work performed until an acceptable program is approved.
- (2) Trainees. Except as provided in 29 CFR 5.16, trainees will not be permitted to work at less than the predetermined rate for the work performed unless they are employed pursuant to and individually registered in a program which has received prior approval, evidenced by formal certification by the U.S. Department of Labor, Employment and Training Administration. The ratio of trainees to journeymen on the job site shall not be greater than permitted under

the plan approved by the Employment and Training Administration. Every trainee must be paid at not less than the rate specified in the approved program for the trainee's level of progress, expressed as a percentage of the journeyman hourly rate specified in the applicable wage determination. Trainees shall be paid fringe benefits in accordance with the provisions of the trainee program. If the trainee program does not mention fringe benefits, trainees shall be paid the full amount of fringe benefits listed in the wage determination unless the Administrator of the Wage and Hour Division determines that there is an apprenticeship program associated with the corresponding journeyman wage rate in the wage determination which provides for less than full fringe benefits for apprentices. Any employee listed on the payroll at a trainee rate who is not registered and participating in a training plan approved by the Employment and Training Administration shall be paid not less than the applicable wage rate in the wage determination for the classification of work actually performed. In addition, any trainee performing work on the job site in excess of the ratio permitted under the registered program shall be paid not less than the applicable wage rate in the wage determination for the work actually performed. In the event the Employment and Training Administration withdraws approval of a training program, the Contractor will no longer be permitted to utilize trainees at less than the applicable predetermined rate for the work performed until an acceptable program is approved.

- (3) Equal employment opportunity. The utilization of apprentices, trainees, and journeymen under this clause shall be in conformity with the equal employment opportunity requirements of Executive Order 11246, as amended, and 29 CFR Part 30.
- (e) Compliance with Copeland Act requirements. The Contractor shall comply with the requirements of 29 CFR Part 3, which are hereby incorporated by reference in this contract.
- (f) Contract termination; debarment. A breach of this contract clause may be grounds for termination of the contract and for debarment as a Contractor and a subcontractor as provided in 29 CFR 5.12.
- (g) Compliance with Davis-Bacon and related Act requirements. All rulings and interpretations of the Davis-Bacon and related Acts contained in 29 CFR Parts 1, 3, and 5 are herein incorporated by reference in this contract.
- (h) Disputes concerning labor standards. Disputes arising out of the labor standards provisions of this clause shall not be subject to the general disputes clause of this contract. Such disputes shall be resolved in accordance with the procedures of the Department of Labor set forth in 29 CFR Parts 5, 6, and 7. Disputes within the meaning of this clause include disputes between the Contractor (or any of its subcontractors) and the PHA, HUD, the U.S. Department of Labor, or the employees or their representatives.
- (i) Certification of eligibility.
 - (1) By entering into this contract, the Contractor certifies that neither it (nor he or she) nor any person or firm who has an interest in the Contractor's firm is a person or firm ineligible to be awarded contracts by the United States Government by virtue of section 3(a) of the Davis-Bacon Act or 29 CFR 5.12(a)(1).

- (2) No part of this contract shall be subcontracted to any person or firm ineligible for award of a United States Government contract by virtue of section 3(a) of the Davis-Bacon Act or 29 CFR 5.12(a)(1).
- (3) The penalty for making false statements is prescribed in the U. S. Criminal Code, 18 U.S.C. 1001.
- (j) Contract Work Hours and Safety Standards Act. As used in this paragraph, the terms "laborers" and "mechanics" include watchmen and guards.
 - (1) Overtime requirements. No contractor or subcontractor contracting for any part of the contract work which may require or involve the employment of laborers or mechanics, including watchmen and guards, shall require or permit any such laborer or mechanic in any workweek in which the individual is employed on such work to work in excess of 40 hours in such workweek unless such laborer or mechanic receives compensation at a rate not less than one and one-half times the basic rate of pay for all hours worked in excess of 40 hours in such workweek.
 - (2) Violation; liability for unpaid wages; liquidated damages. In the event of any violation of the provisions set forth in subparagraph (j)(1) of this clause, the Contractor and any subcontractor responsible therefor shall be liable for the unpaid wages. In addition, such Contractor and subcontractor shall be liable to the United States (in the case of work done under contract for the District of Columbia or a territory, to such District or to such territory), for liquidated damages. Such liquidated damages shall be computed with respect to each individual laborer or mechanic (including watchmen and guards) employed in violation of the provisions set forth in subparagraph (j)(1) of this clause, in the sum of \$27 for each calendar day on which such individual was required or permitted to work in excess of the standard workweek of 40 hours without payment of the overtime wages required by provisions set forth in subparagraph (j)(1) of this clause. DOL posts current fines at: <https://www.dol.gov/whd/govcontracts/cwhssa.htm#cmp>
 - (3) Withholding for unpaid wages and liquidated damages. HUD or its designee shall upon its own action or upon written request of an authorized representative of the Department of Labor withhold or cause to be withheld, from any moneys payable on account of work performed by the Contractor or subcontractor under any such contract or any Federal contract with the same prime Contractor, or any other Federally-assisted contract subject to the Contract Work Hours and Safety Standards Act, which is held by the same prime Contractor, such sums as may be determined to be necessary to satisfy any liabilities of such Contractor or subcontractor for unpaid wages and liquidated damages as provided in the provisions set forth in subparagraph (j)(2) of this clause.
- (k) Subcontracts. The Contractor or subcontractor shall insert in any subcontracts all the provisions contained in this clause, and such other clauses as HUD or its designee may by appropriate instructions require, and also a clause requiring the subcontractors to include these provisions in any lower tier subcontracts. The prime Contractor shall be responsible for the compliance by any subcontractor or lower tier subcontractor with all these provisions.

47. Non-Federal Prevailing Wage Rates

(a) Any prevailing wage rate (including basic hourly rate and any fringe benefits), determined under State or tribal law to be prevailing, with respect to any employee in any trade or position employed under the contract, is inapplicable to the contract and shall not be enforced against the Contractor or any subcontractor, with respect to employees engaged under the contract whenever such non-Federal prevailing wage rate exceeds:

(1) The applicable wage rate determined by the Secretary of Labor pursuant to the Davis-Bacon Act (40 U.S.C. 3141 et seq.) to be prevailing in the locality with respect to such trade;

(b) An applicable apprentice wage rate based thereon specified in an apprenticeship program registered with the U.S. Department of Labor (DOL) or a DOL-recognized State Apprenticeship Agency; or

(c) An applicable trainee wage rate based thereon specified in a DOL-certified trainee program.

48. Procurement of Recovered Materials.

(a) In accordance with Section 6002 of the Solid Waste Disposal Act, as amended by the Resource Conservation and Recovery Act, the Contractor shall procure items designated in guidelines of the Environmental Protection Agency (EPA) at 40 CFR Part 247 that contain the highest percentage of recovered materials practicable, consistent with maintaining a satisfactory level of competition. The Contractor shall procure items designated in the EPA guidelines that contain the highest percentage of recovered materials practicable unless the Contractor determines that such items: (1) are not reasonably available in a reasonable period of time; (2) fail to meet reasonable performance standards, which shall be determined on the basis of the guidelines of the National Institute of Standards and Technology, if applicable to the item; or (3) are only available at an unreasonable price.

() Paragraph (a) of this clause shall apply to items purchased under this contract where: (1) the Contractor purchases in excess of \$10,000 of the item under this contract; or (2) during the preceding Federal fiscal year, the Contractor: (i) purchased any amount of the items for use under a contract that was funded with Federal appropriations and was with a Federal agency or a State agency or agency of a political subdivision of a State; and (ii) purchased a total of in excess of \$10,000 of the item both under and outside that contract.



Procurement Department
675 West Main Street
Rochester, NY 14611
(585) 697-3625 (585) 697-7164 Fax
WWW.ROCHESTERHOUSING.ORG

5/26/11

TO: Contractors Performing Work for the Rochester Housing Authority

RE: Policy regarding: Three (3) contract limit, dollar threshold contract limit, shared interest in multiple businesses, and shared insurance for multiple businesses.

The RHA, in accordance with HUD regulations and HUD Handbook 7460.8 Rev. 2, awards construction contracts to the lowest Responsible, Responsive bidder whose bid conforms to the solicitation. The RHA will qualify an apparent low bidder to determine if they are Responsible and Responsive. The RHA may require statements of business, sub-business and/or financial records of contractors as part of the qualifying process. Per HUD 24 CFR 85.36 (b) (9) and HUD 5369 (d), RHA may reject any and all bids for any reason. Some of the reasons RHA may reject a bid by way of example are as follows:

The RHA may reject a contractor's bid and disallow them from contract award for performing more than three (3) separate contracts for RHA at one time.

The RHA may reject a contractor's bid and disallow them from contract award if their current contracted dollar amount of work with RHA exceeds \$1,000,000.00.

The RHA may reject a contractor's bid and disallow them from contract award if RHA believes that an individual has an interest in more than one of the bidding companies. This would include a company in which a bidder is part owner, an employee of, has an employee that is bidding as a separate entity, or is a/has a family member in another bidding company. This may also include bidders that have performed work as a subcontractor within the last three months for another bidding firm.

The RHA may reject a contractor's bid if two different contractors have two separate RHA contractor accounts with one insurance certificate listing them both.

The RHA may reject a successful bidder hiring a competing bidder as a subcontractor or employee on any RHA jobs in which both companies submitted a bid.

Any company meeting any of the criteria listed above and could have a contract rejected, may submit a written request to the RHA Procurement Department (prior to the bid submission date) to request that RHA consider their bid. The request should state why RHA should consider the bid, the relationship and/or business history between the two parties, and/or why the company feels that there is not a conflict of interest between the two parties bidding on the same work. A determination will be made by the RHA Contracting Officer or his/her designee before the bid submission deadline whenever possible. The RHA may not accept any written requests for consideration after the bid submission deadline.



Procurement Department
675 West Main Street
Rochester, NY 14611
585-697-6182
procurementRHA@rochesterhousing.org

RHA Contractor/Vendor Section 3 Goals

What Is Section 3?

Section 3 is a provision of the Housing and Urban Development Act of 1968. The purpose of Section 3 is to ensure that employment and other economic opportunities generated by certain HUD financial assistance shall, to **the greatest extent feasible**, and consistent with existing Federal, State, and local laws and regulations, be directed to low- and very low-income persons, particularly those who are recipients of government assistance for housing, and to business concerns which provide economic opportunities to low- and very low-income persons.

RHA SECTION 3 CONTRACTOR/VENDOR COMMITMENT FORM

INSTRUCTIONS: All contractors/vendors **MUST** complete this Section 3 commitment form as part of their bid/proposal, or to amend a commitment after a contract has been successfully awarded. Please answer the questions, **AS PROMPTED**. This form must be signed when completed. If additional forms are required, it will be noted in the appropriate section of this form.

Is your company an RHA recognized Section 3 Business Concern? (Check one) YES _____ NO _____

If **YES**, provide RHA Section 3 Business Concern Certificate, initial clauses (a - e), and complete signature page at the bottom of this form.

If **NO**, initial clauses (a - e) and continue to Question 2:

1. As a recipient of a Section 3 covered contract you, the company, understand the obligations of a Section 3 covered contract and certify to the following: (please read each clause carefully, and initial on the line next to each clause)
 - a. _____ The work to be performed under this contract is subject to the requirements of Section 3. The purpose of Section 3 is to ensure that employment and other economic opportunities generated by HUD assistance to **the greatest extent feasible**, be directed to low-income persons, particularly persons who are recipients of RHA assistance for housing.
 - b. _____ The parties (RHA and the Contractor) to the contract agree to comply with HUD's regulations.
 - c. _____ The company agrees to send to each labor organization or representative or workers with which the contractor has a collective bargaining agreement or other understanding, if any, a notice advising the labor organization or workers' representative of the company's commitments under this Section 3 clause and will post copies of the notice in conspicuous places at the work site where both employees and applicants for training and employment positions can see the notice. (This is **only** required for **new (unfilled)** employment opportunities for this project, before the project start, **or** that arise **during the project**)
 - d. _____ The company agrees to include this Section 3 clause in every subcontract.

2. Does your company or subcontractor need to hire additional labor **for this project**? YES ___ NO ___
(Check one and initial clause)

_____ Contractor/Vendor agrees to interview RHA supplied, low-income candidates (if available) for **open** positions before the start of the project or that arise **during the project**. (contractor/vendor is not required to hire candidates who are not qualified for the open position(s) but must provide an interview opportunity)

3. Does your company have **unfilled** subcontracts for this project? YES ___ NO ___ (Check one and initial clauses)

_____ Contractor/Vendor agrees to notify the RHA if/when a need to subcontract occurs **during the project**.

_____ Contractor/Vendor agrees to interview/negotiate with RHA supplied, low-income subcontractor candidates (if available) for the needed service (if needed). (**contractor/vendor is not required to subcontract to businesses not qualified for the needed services or who cannot supply the services at an agreeable price**)

4. _____ Contractor/Vendor agrees to submit a list of all employees who worked on the project including subcontractor employees stating the employee's address, date of hire, income at date of hire and current annual income. (This will be a fillable close out document supplied by RHA)

5. _____ Contractors agrees to submit certified payrolls for all contracts \$2,000 or more.

I/we (*name of company*) _____ located at

(*Address of company*) _____

By signing below, the company acknowledges and understands that it has reviewed RHA's Section 3 compliance requirements and agrees to comply with the selected commitments indicated above. Contractor/Vendor attests that the proof supplied, and representations made for Section 3 status are accurate, to the best of its knowledge and belief and understands that any intentional submission of false information shall be a material breach of the contract. To the extent that the completion of this form is contingent upon future information, for example price negotiations, request for specific services, etc., the undersigned hereby affirms and agrees to fully adhere in good faith to the RHA Section 3 compliance goals. The undersigned acknowledges and affirms responsibility for completion and submission of this form PRIOR TO AWARD of a contract and acknowledges that failure to submit this form may jeopardize the responsiveness of its submission.

Signature

Date

Title of Signatory

For any questions regarding this Form, please contact Melissa Berrien at mberrien@rochesterhousing.org or 585-232-1112 ext. 229

Scope of Work

Danforth Towers Façade Repairs-Ph II

This is a competitively bid single-prime project for the Façade Repairs-Phase II of Danforth Towers East and West located at 140/160 West Ave., Rochester, NY 14611. Repairs and sealants were done recently to most areas above grade and some below grade. This project is for the balance of cleaning, masonry repairs and sealants on or around the buildings.

- Contractor to verify all areas that may need repair and coatings and responsible for quantities of all. See pictures for most locations in need of work.
- Prior to start of reconstruction, contractor is to power wash all masonry that was not finished previously with CLR or equal. The stone areas will need to be scrubbed with a brush to remove the buildup of pollution, dirt and rust. Some areas where work is to be performed may have mold that will have to be cleaned off of the masonry with a proper cleaning product. All products need to be ECO-friendly to all surrounding elements, people and pets.
- Contractor is to clean out loose concrete/cement and point all cracks in concrete areas that are at or below grade and under canopies that have not been done. This includes retaining walls, some connections to sidewalks and below grade areas.
- Cracked stone areas will need to be chipped out and replaced in kind.
- Contractor to install caulk in balance of areas where the building masonry meets the sidewalks.
- Contractor to install backer rod in between the retaining walls and building connections, and seal the gaps with caulk.
- Contractor to caulk around vents where it missing or deteriorated. Some old caulk will need to be removed.
- Grading and additional topsoil will need to be added at stair area on side/rear of building 140. The soil has eroded over time and has undercut the concrete.
- Sidewalk in front of right-side door of building 140 will need to be parged where it has deteriorated.
- Finish coating on masonry (not stone) to be Sika products as listed in the specifications to match existing.
- See attachments for some, but not all, locations that exist for repairs.
- Contractor to make sure that all weep holes remain open and intact.
- Contractor's mason(s) need to be Sika certified to utilize their products, either at the time of bid submittal or prior to start of project.

Contractor to contact RHA's Sr. PRS for onsite support of any situations that may arise that need to be addressed.

Contractor to verify all existing conditions and report to RHA's Sr. PRS if determined that unforeseen circumstances arise and field changes are required.

Contractor and their employees shall comply with OSHA requirements at all times on job site. Failure to do so could lead to breach and termination of contract.

Contractor is responsible for and needs to ensure the safety and health of tenants, employees and all others at the site and at all times once the project is under contract. The contractor and his/her employees shall follow all construction means and methods to ensure safety. This shall also apply during inclement weather where additional measures need to take place around the construction site and parking lots for safe entry to units/building. Contractor to construct or provide those means of entry/exit to each unit and/or building if the need arises. Construction site is to be picked up at the end of each day and tools and materials put away. Debris is to be collected and disposed of properly. The ground is to be raked clean, sidewalks swept clean and entry/exit areas available to the residents upon completion each day. Contractor to only place dumpster in a location that is out of the way and danger of anyone living in the complex, visiting or passing by and to be confirmed with management of the complex. Dumpsters need to be covered at night and taped-off when no work is going on.

Contractor to perform all contract work in accordance with the contract specifications, Federal and State Regulations and all other applicable codes.

Contractor to coordinate the scheduled work with the owner's representative.

Contractor to adhere to working hours from 8:30 am-4:30 pm Monday thru Friday only unless special permission is granted from RHA or it's assignees. All requests must be in writing.

Danforth Towers Façade Repairs Ph II

LEGEND (all masonry to be power sprayed clean with CLR first-**Caution-all finished masonry in conjunction with these areas are to be protected.* Tape-off with plastic or other to prevent overspray on any finished masonry. Contractor to be responsible for repairs to effected areas.)-Note: Not all areas may be defined. Contractor to verify all areas and total amounts of materials.

1	Point Masonry
2	Caulk Joint(s)-including all in the area
3	Clean Out Joint and Install Backer Rod and Caulk
4	Chip Out and Repair TME
5	Parge with Cement
6	Coat with Sika Products –Contractor to verify quantities for all elastomeric coatings and sealants.
7	Add Topsoil and Grass or Mulch

See specifications manual for material information and installation processes. Not all information may be applicable

BUILDING CODE DATA

CODE:2020 EXISTING BUILDING CODE OF NEW YORK STATE (EBC)
 OCCUPANCY: RESIDENTIAL, GROUP R-2
 CONSTRUCTION: TYPE I-B
 CLASSIFICATIONS OF WORK
 ALTERATION - LEVEL I PER CHAPTER 6, SECTION 602 (EBC)
 REMOVAL AND REPLACEMENT OF EXISTING BUILDING ELEMENTS
 THAT SERVE THE SAME PURPOSE.
 COMPLIANCE WITH CHAPTER 7 - ALTERATIONS LEVEL I

"ALL" POWERASHING SHALL BE DONE FIRST. CONTRACTOR SHALL
 "CHASE DOWN" WASH TO PREVENT STAINING BELOW.

BRICK MASONRY RESTORATION.

PATCHING AND REPAIR OF CONCRETE.

PROVIDE WATER REPELLENTS AT ALL BRICK MASONRY. SEE SECTION
 07 1900.

PROVIDE ELASTOMERIC COATING AT ALL CONCRETE. SEE SECTION
 09 8300.

AREAS TO RECEIVE WATER REPELLANT WILL BE
 TESTED PER SECTION 07 1900.

PROVIDE SEALANT REPLACEMENT AT WINDOWS, BRICK, CONCRETE .

ALL CONSTRUCTION SHALL CONFORM TO THE
 2016 EXISTING BUILDING CODE OF NEW YORK
 STATE AND CURRENT NYS SUPPLEMENTS.

THE CONTRACTOR SHALL VISIT THE SITE AND
 EXAMINE EXISTING CONDITIONS PRIOR TO
 SUBMITTING A BID. BIDS SHALL INCLUDE
 PROVISIONS FOR A COMPLETE JOB BASED ON
 THE DESIGN INTENT SHOWN ON THE DRAWINGS.

THE CONTRACTOR SHALL VERIFY ALL
 CONDITIONS, DIMENSIONS, AND ELEVATIONS OF
 THE CONSTRUCTION AS SHOWN, AND
 IMMEDIATELY NOTIFY THE RHA AND ARCHITECT
 OF ANY DISCREPANCIES. IT IS THE
 CONTRACTOR'S RESPONSIBILITY TO PROVIDE
 THE PROJECT SCOPE PER VERIFIED FIELD
 CONDITIONS.

AREAS OF THE SITE AND ANY EXISTING
 CONSTRUCTION TO REMAIN, IF DAMAGED
 DURING CONSTRUCTION, SHALL BE RESTORED
 TO ITS ORIGINAL CONDITION AT NO COST TO
 THE RHA.

COORDINATE USE OF THE EXISTING SITE AND
 PREMISES WITH THE RHA AND ARCHITECT.
 LOCATION OF STORED MATERIALS SHALL BE
 COORDINATED WITH THE RHA. THE RHA IS NOT
 RESPONSIBLE FOR STORED MATERIALS THAT ARE
 DAMAGED OR STOLEN.

**PROTECT, PATCH, REPAIR AND PAINT EXISTING
 CONSTRUCTION TO REMAIN AS REQUIRED DUE
 TO REMOVALS, INSTALLATION OF NEW WORK,
 AND/OR AS REQUIRED TO RECEIVE NEW WORK.**

**REMOVE ALL DEMOLISHED ITEMS ON A DAILY
 BASIS.**

**SEE DIVISION 1 SECTIONS 01 1100 AND
 01 5100 FOR FURTHER REQUIREMENTS. SEE
 SECTION 02 4120 FOR SELECTIVE DEMOLITION.
 CONTRACTOR SHALL BE CERTIFIED AND
 PERFORM REMOVALS IN ACCORDANCE WITH THE
 ENVIRONMENTAL PROTECTION AGENCY (EPA)
 LEAD-SAFE WORK PRACTICES.**

**CONTRACTOR MUST SUPPLY A TWO YEAR LABOR
 WARRANTY ON ALL WORK BEING PERFORMED.**

MANUFACTURER / PRODUCT STANDARDS

THE DRAWINGS, DETAILS AND SPECIFICATIONS ARE BASED ON PREPARATION AND PRODUCTS FROM ONE MANUFACTURER. THESE PRODUCTS AND REQUIREMENTS SERVE AS THE STANDARD OF QUALITY FOR CONTRACT WORK. OTHER MANUFACTURERS WHO MEET OR EXCEED THESE REQUIREMENTS SHALL BE SUBMITTED IN ACCORDANCE WITH SPECIFICATION SECTIONS 01 2500 AND 01 2519 FOR SUBSTITUTIONS.

NOTE THAT THESE PRODUCTS ARE PROVIDED AS A SYSTEM WITH COMPATIBILITY REQUIREMENTS. MIXING PRODUCTS FROM DIFFERENT MANUFACTURERS WILL NOT BE ACCEPTED.

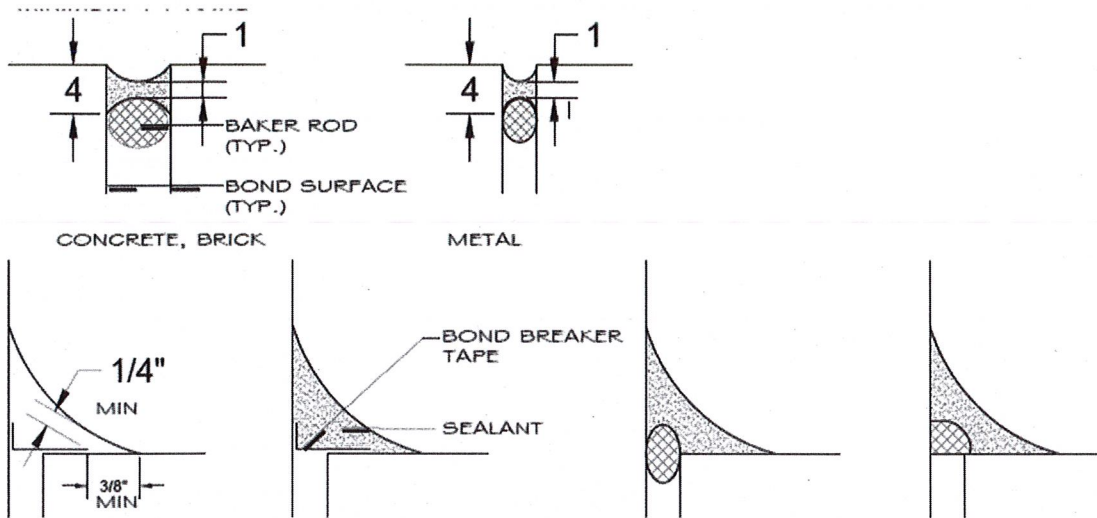

5 DETAIL - SEALANT JOINTS
NTS 07 9200

SC 066 Sikagard 701 W

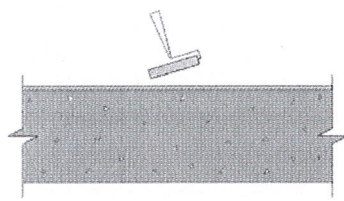

1. Surface must be clean, sound and free of standing water.
 Note: While residual moisture does not affect the treatment, the drier the substrate the better the penetration and protection.
2. Apply Sikagard 701W laterally by roller, brush (horizontal surface) or spray.
 Note: When spraying, it is advisable to use hand-pressure equipment rather than compressed-air drive.

DETAIL - CONCRETE REPAIRS

NTS 07 1900

Figure 1 - Surface Seal

1. Surface seal cracks up to a ¼" wide by gunning **Sikaflex-1a** into crack.
2. Tool as required to properly fill crack.

Note:

Prior to applying any coating, allow sealant to cure for 7 days.

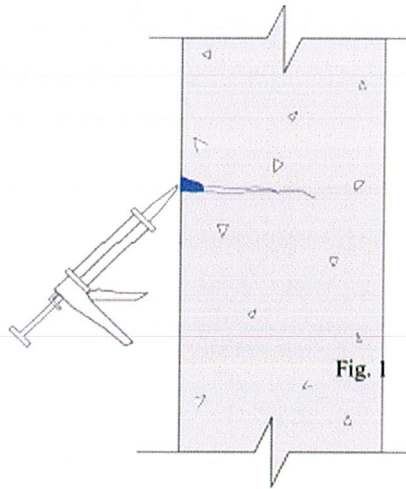
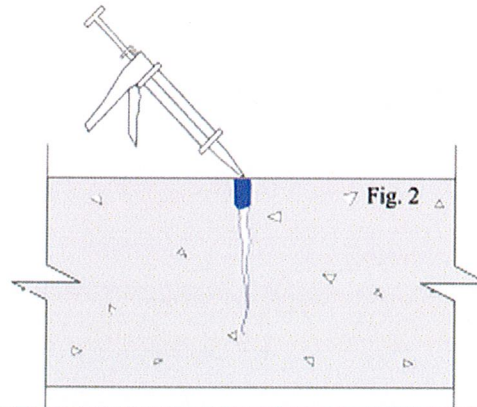

Figure 2 - Notch & Seal

1. Gun **Sikaflex-1a** into prepared crack to a minimum depth of ¼".
2. Tool as required to properly fill crack.



Concrete Restoration Systems by Sika Corporation, 201 Polito Avenue, Lyndhurst, NJ 07071

DETAIL - CONCRETE REPAIRS

NTS

07 9000

SC-058 Sikagard® 550W Elastocolor, Anti-Carbonation Crack-bridging Coating

1. Substrate must be dry, clean and sound.
2. Condition surface with Sikagard 552W or SikaLatex R(as needed)
3. Apply base coating as needed
4. Apply Sikagard 550W Elastocolor by brush, roller or spray over entire area moving in one direction.

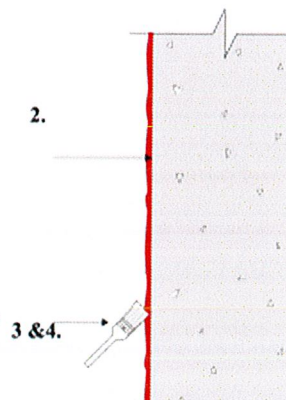

DETAIL - CONCRETE COATING

NTS

09 8300

Danforth Tower East-140 West Ave

Clean with CLR-
Typical

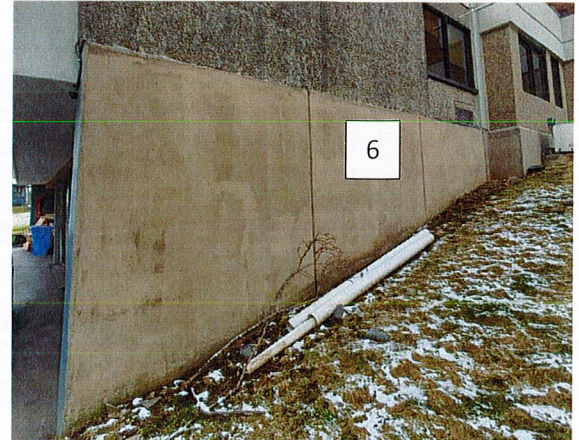
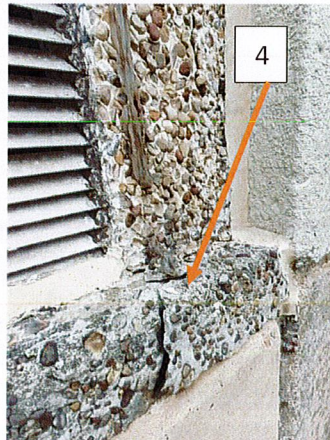
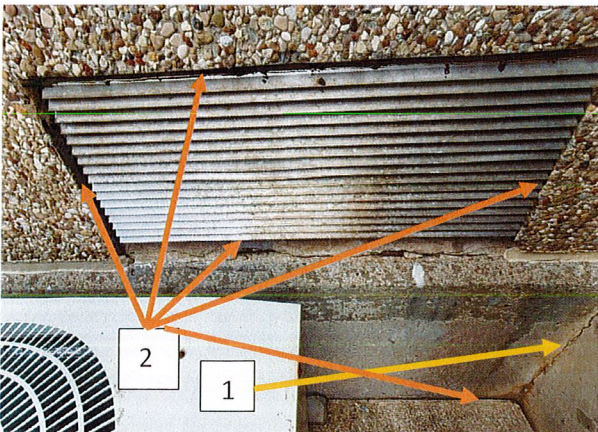
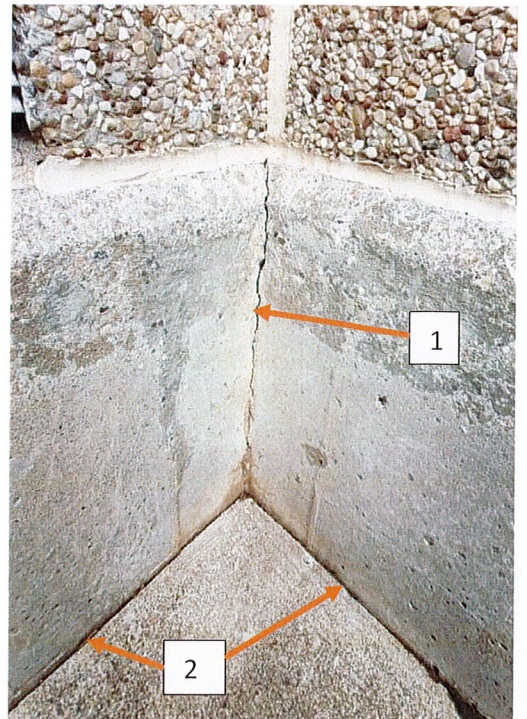
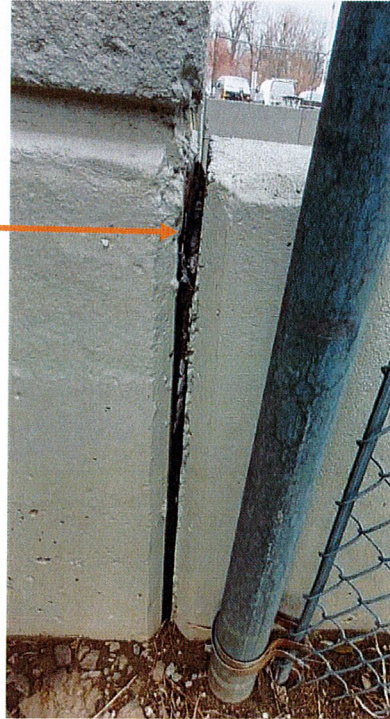
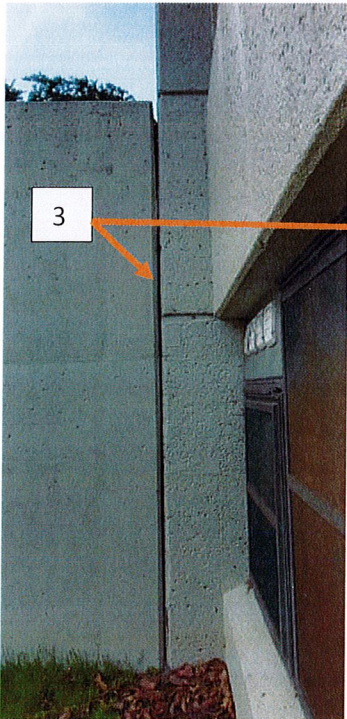
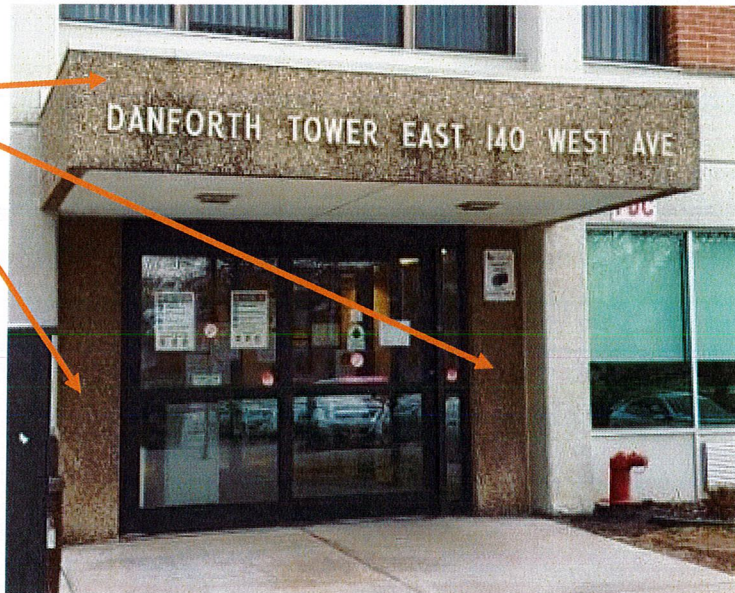

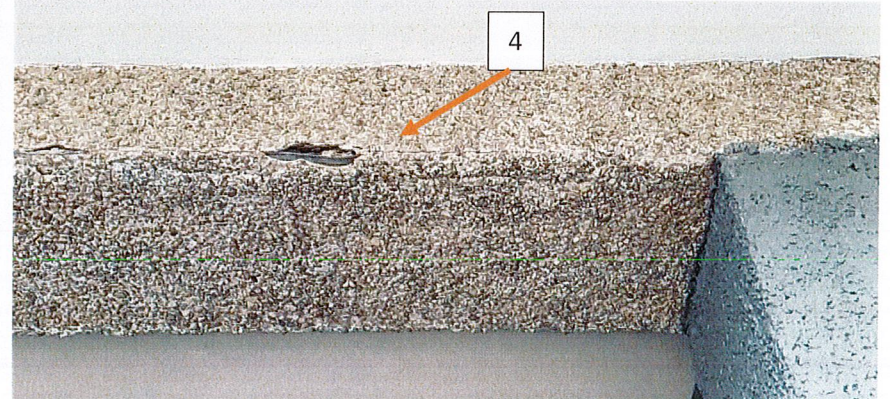
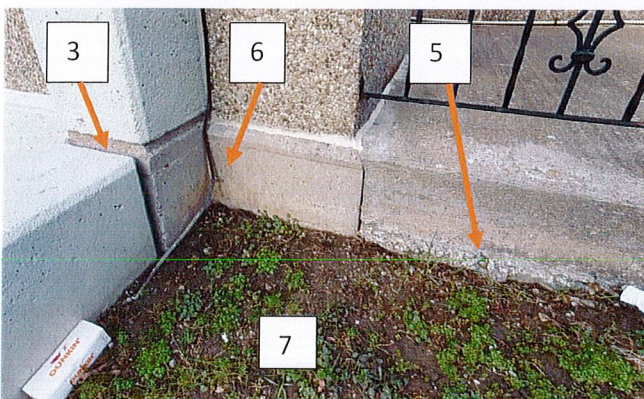
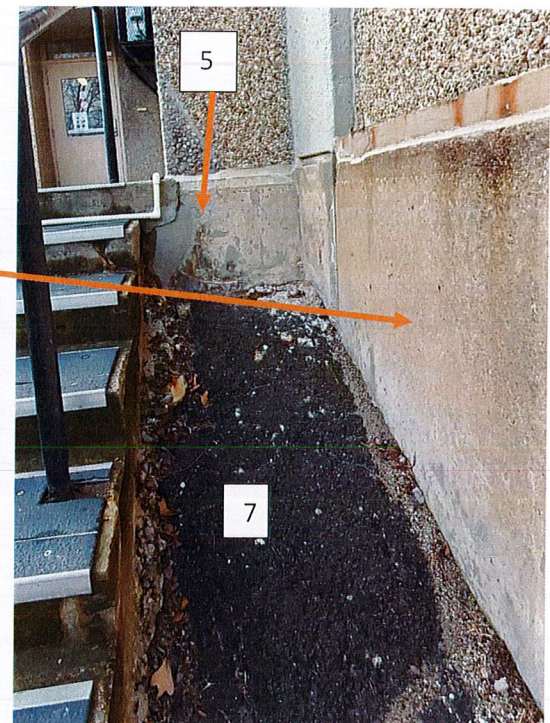
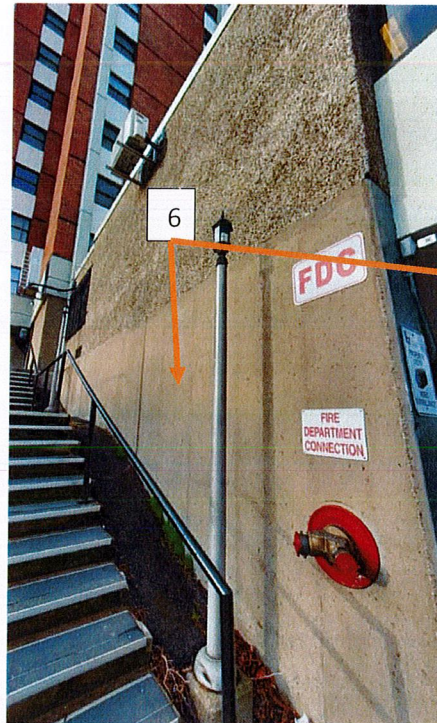
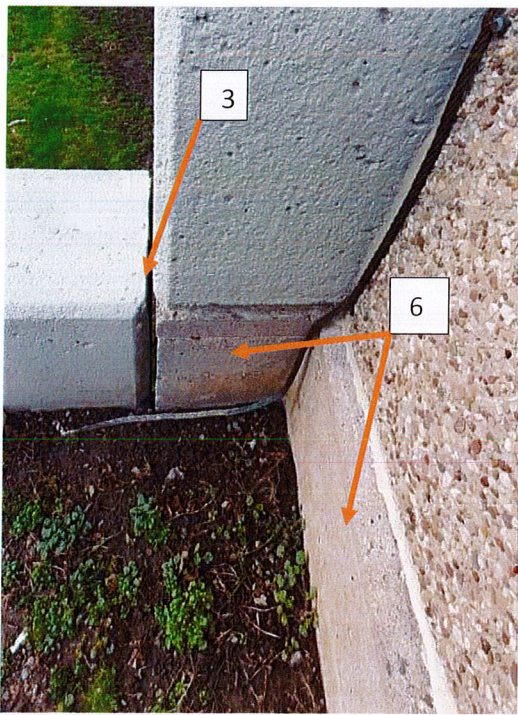

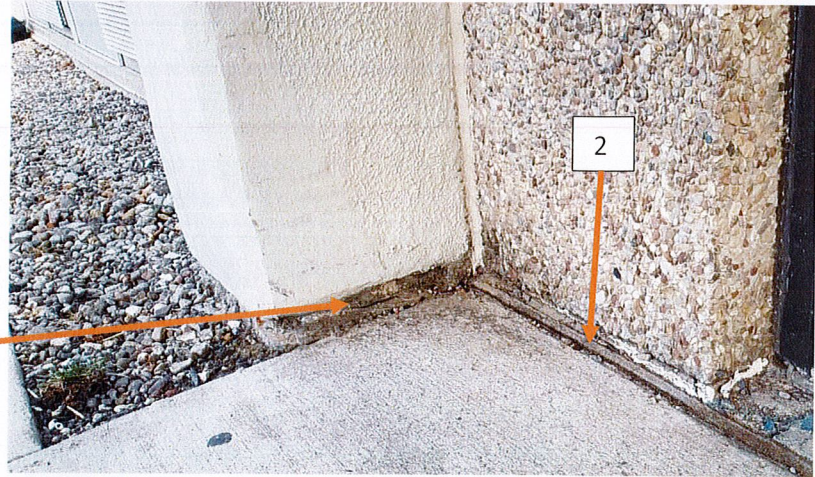
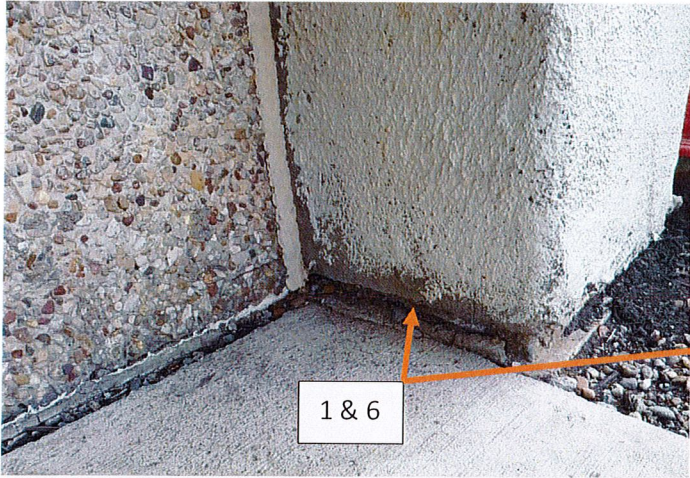
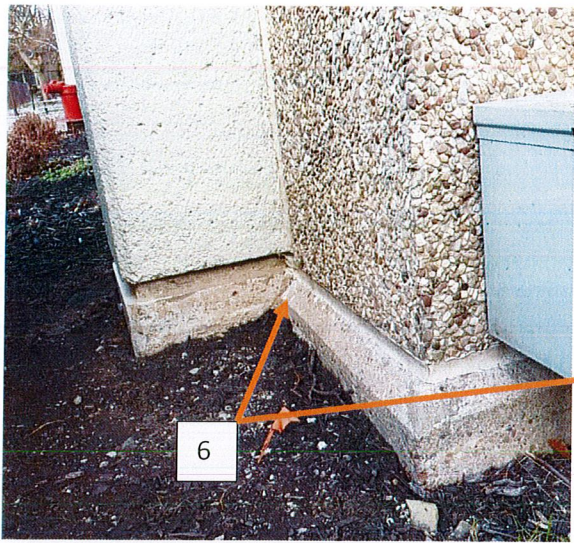

Danforth Tower West-160 West Ave.

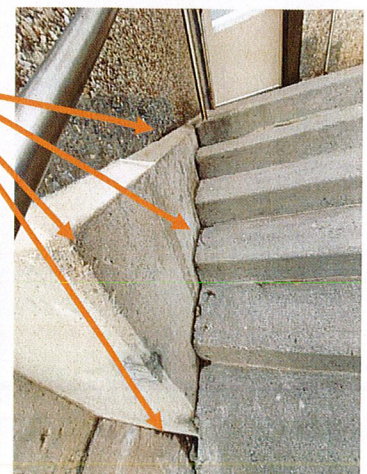
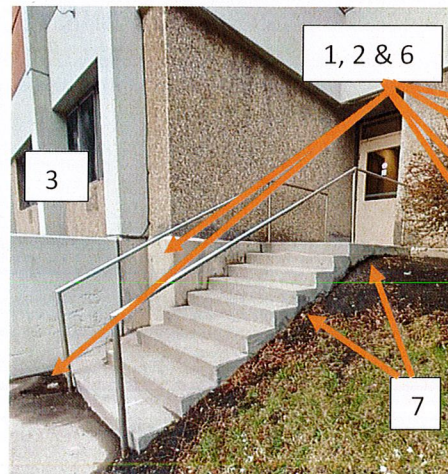
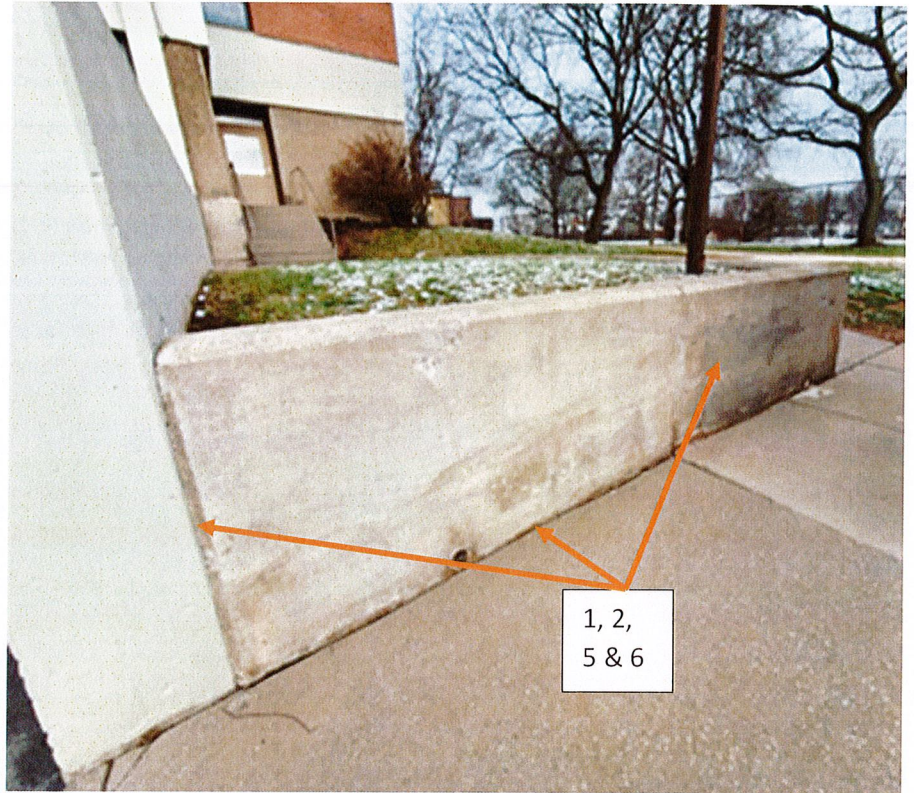
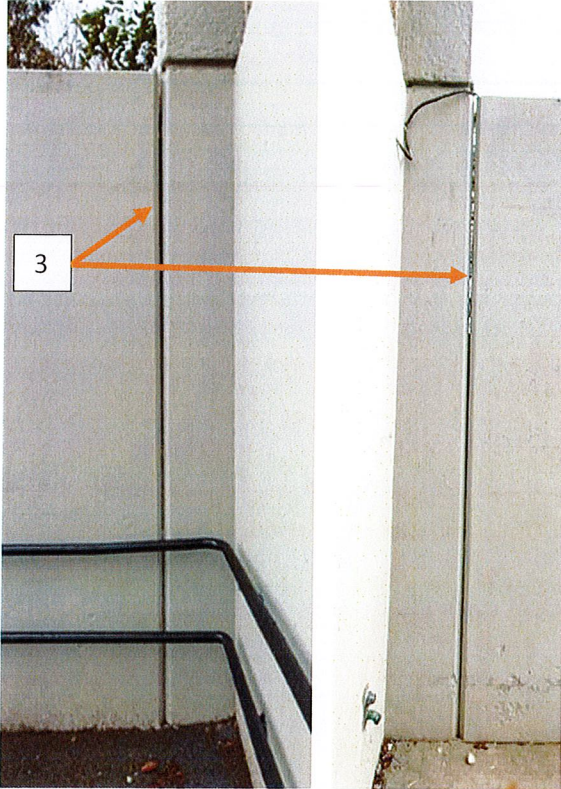

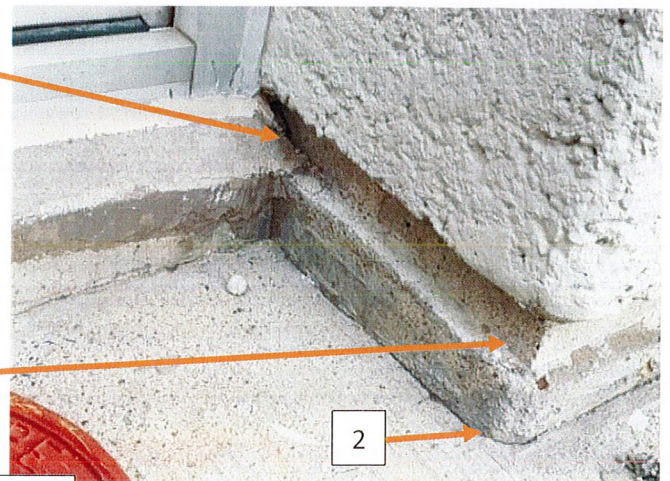
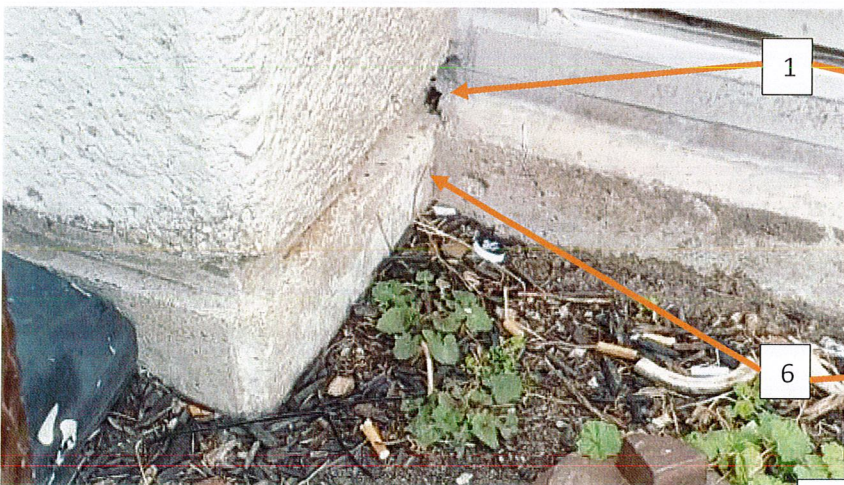
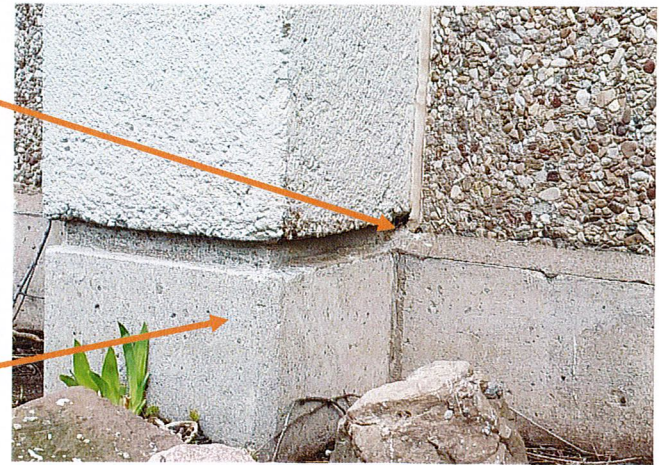
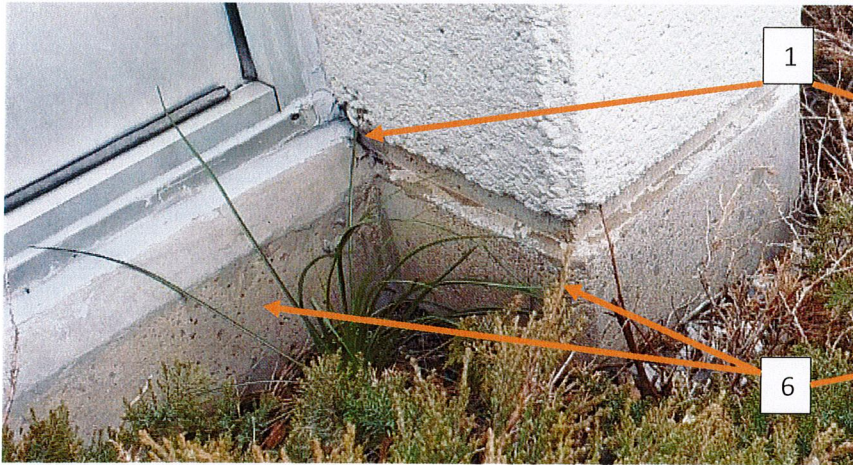
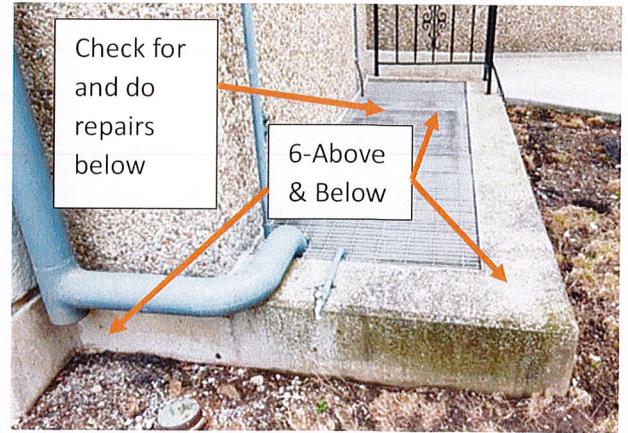
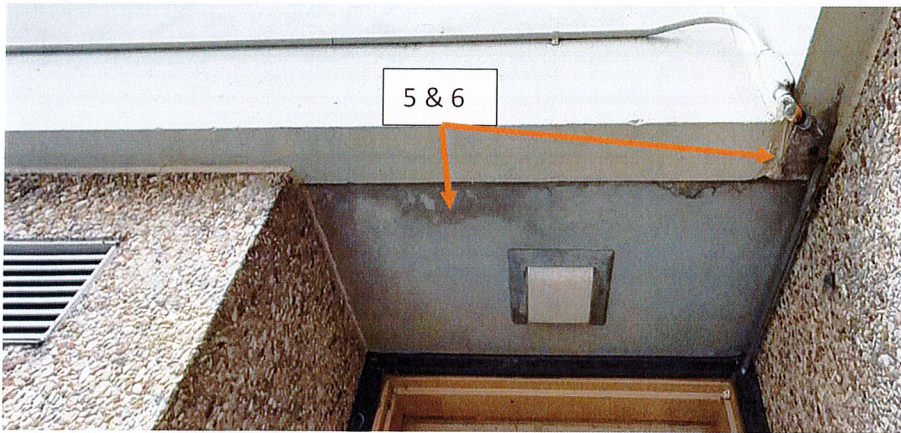
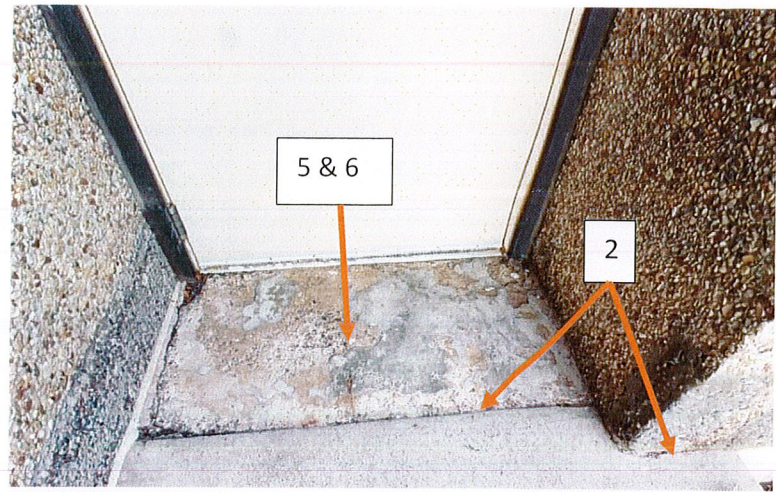
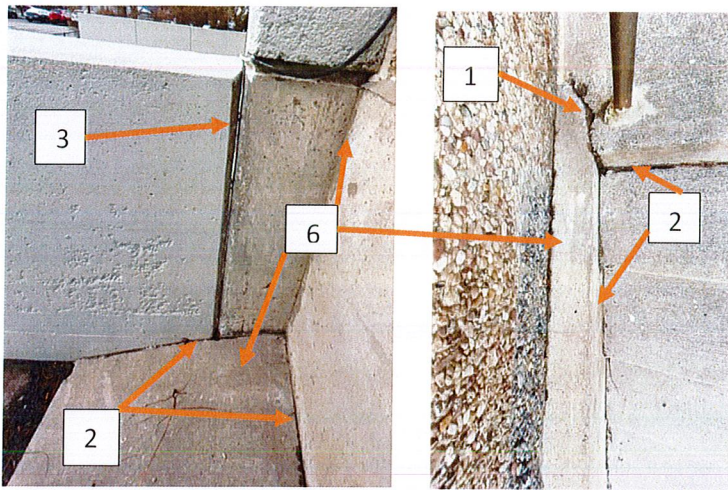

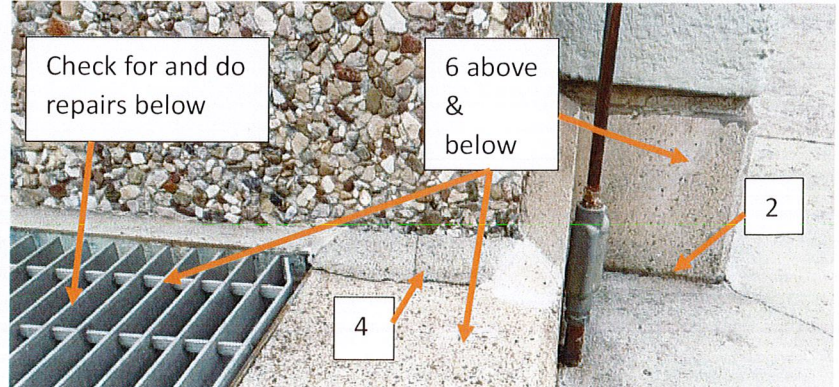
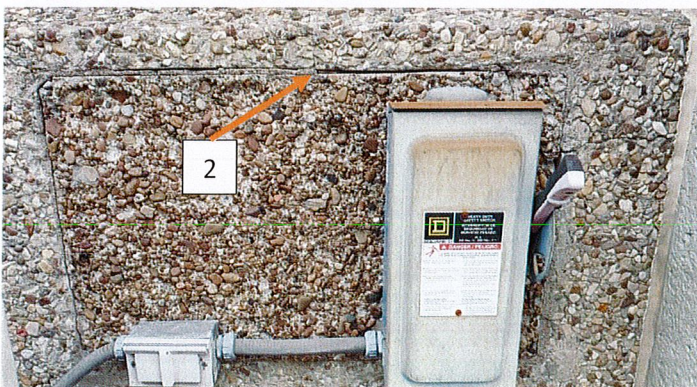
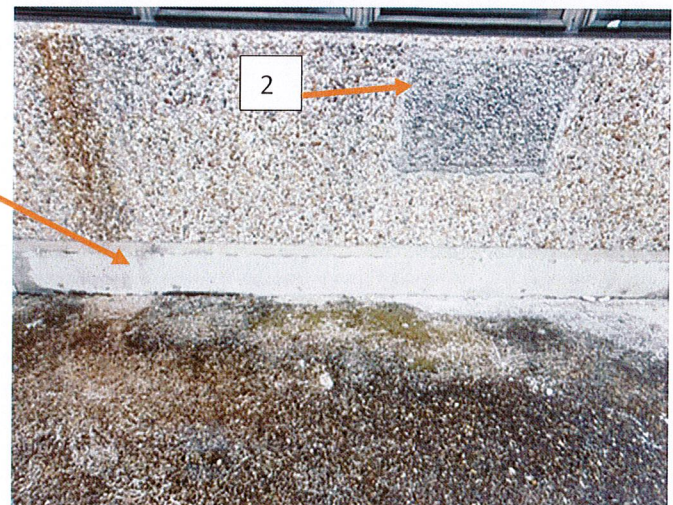
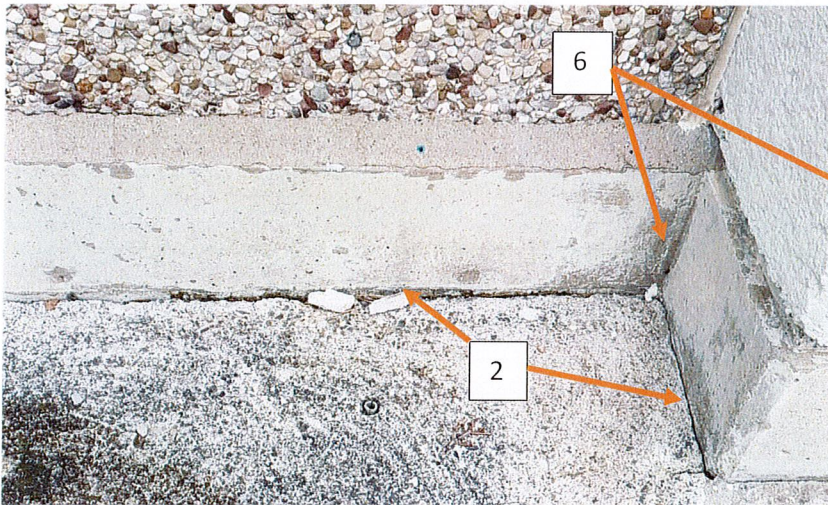
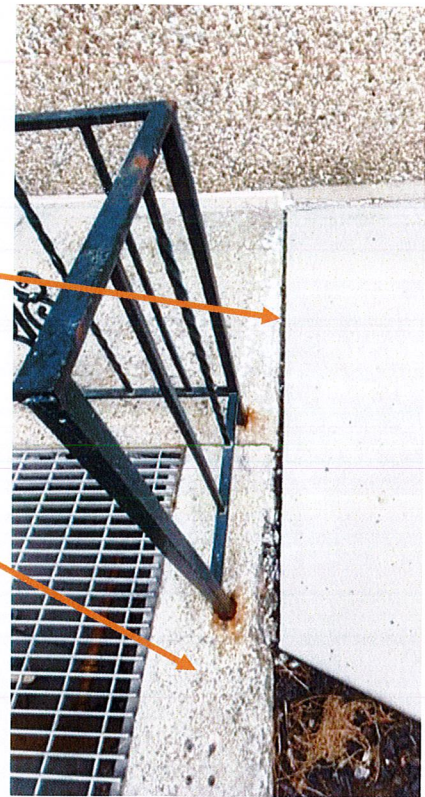
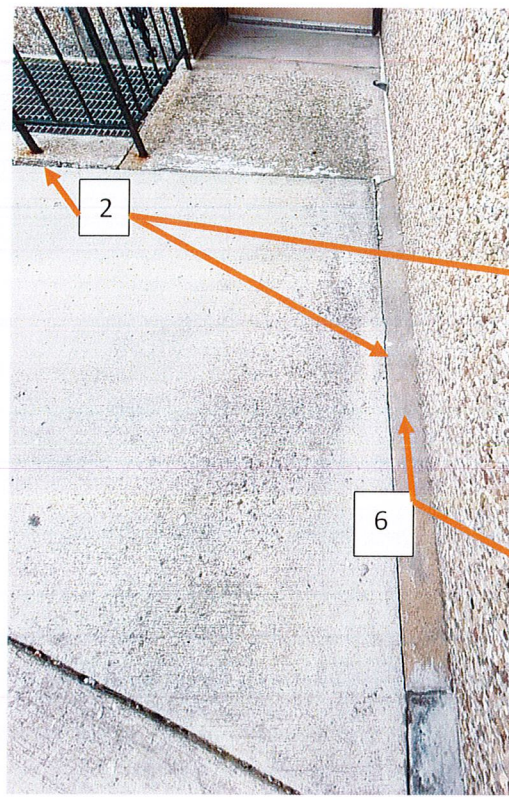

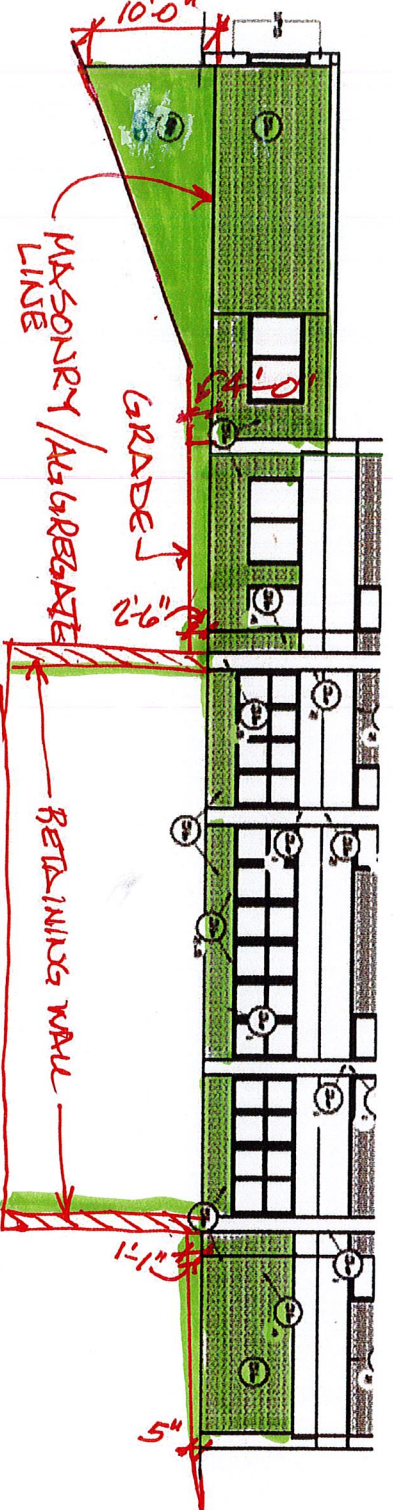
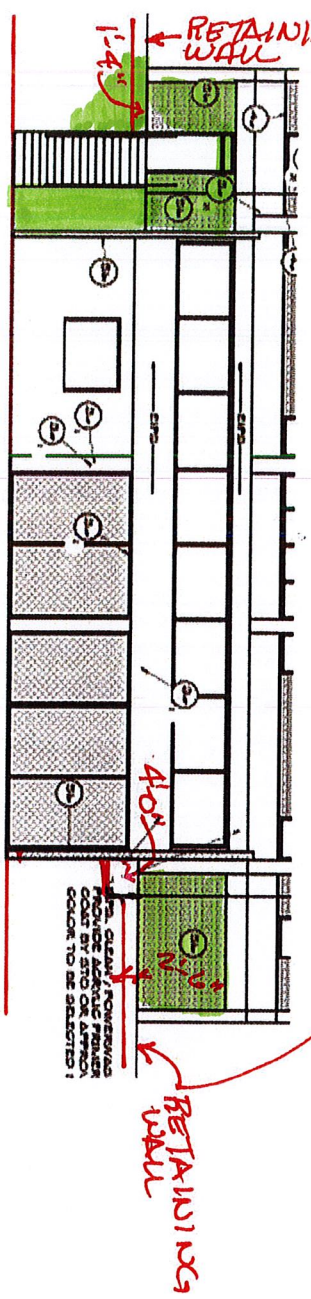
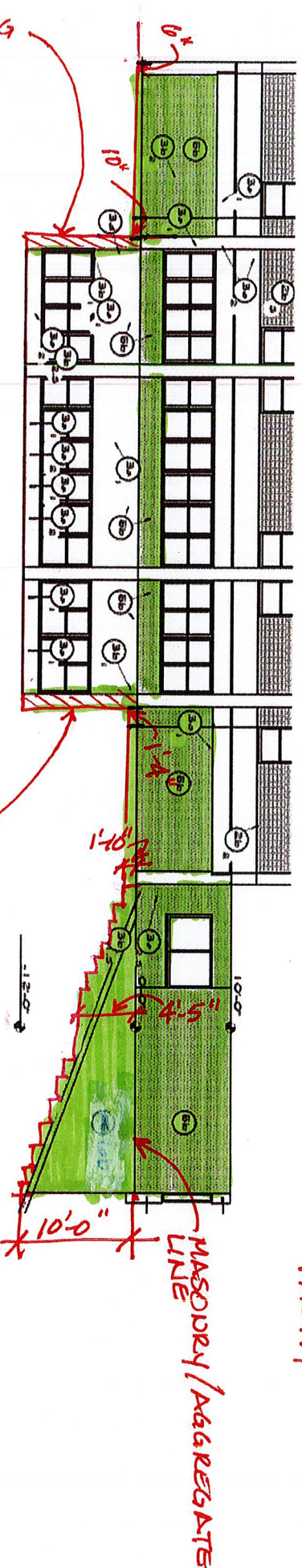
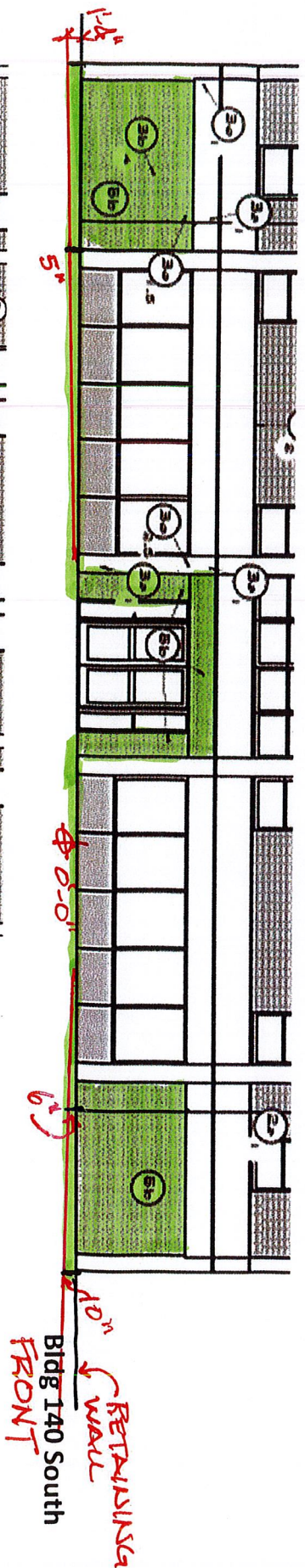

NOTE: ALL DIMENSIONS ARE +/- (CONTRACTOR TO VERIFY)

INDICATES MOST AREAS OF CLEANING, REPAIRS & SEALANT

LEFT SIDE (DTE) 140

REAR Bldg 140 North

Bldg 140 East RIGHT SIDE

Bldg 140 South FRONT

LEFT SIDE Bldg 140 West

NOTE: ALL DIMENSIONS ARE +/-

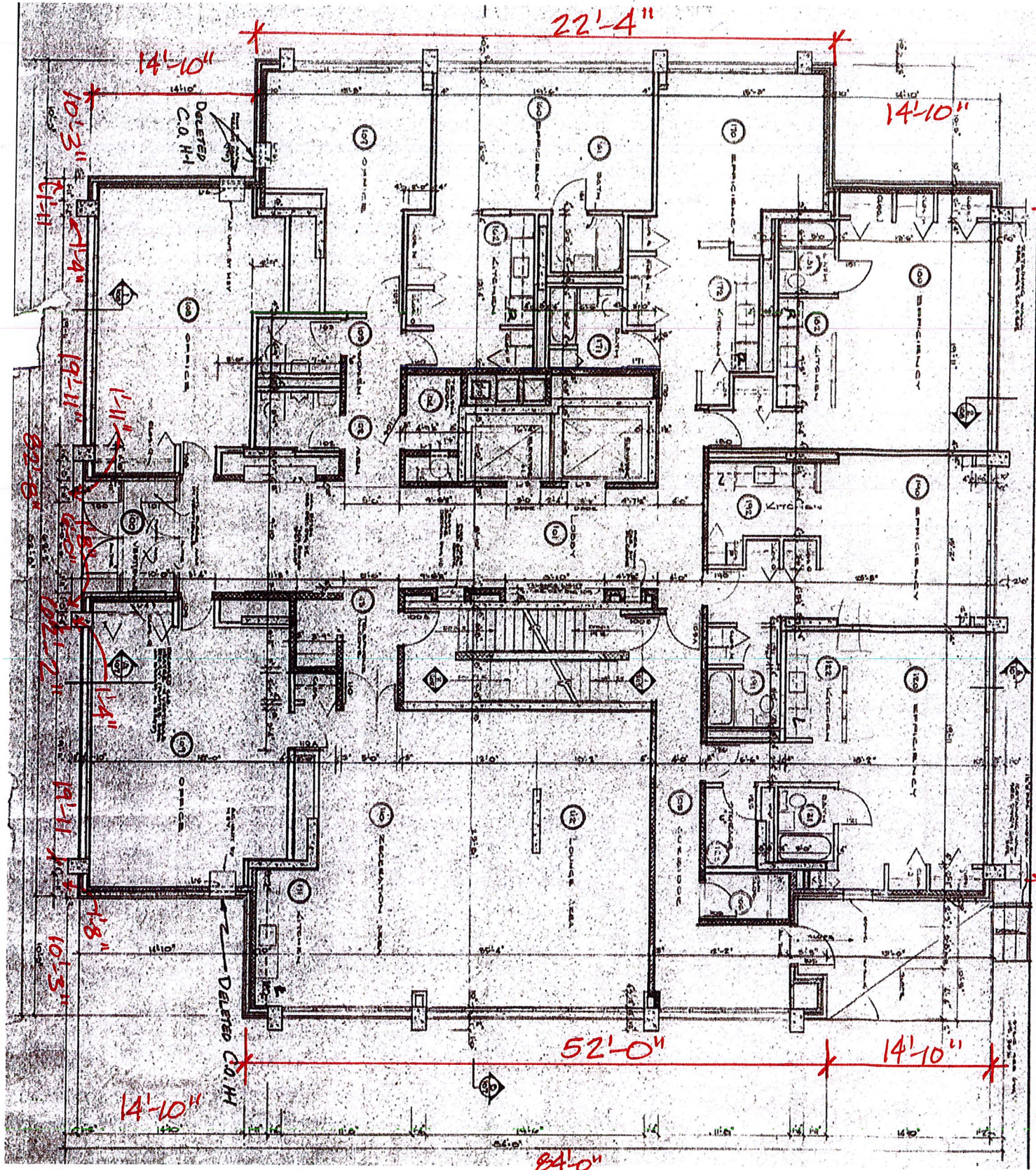

28'-4" ADDITION (SEE ATTACHED)

DTE (140)

NOTE: ALL DIMENSIONS ARE +/-

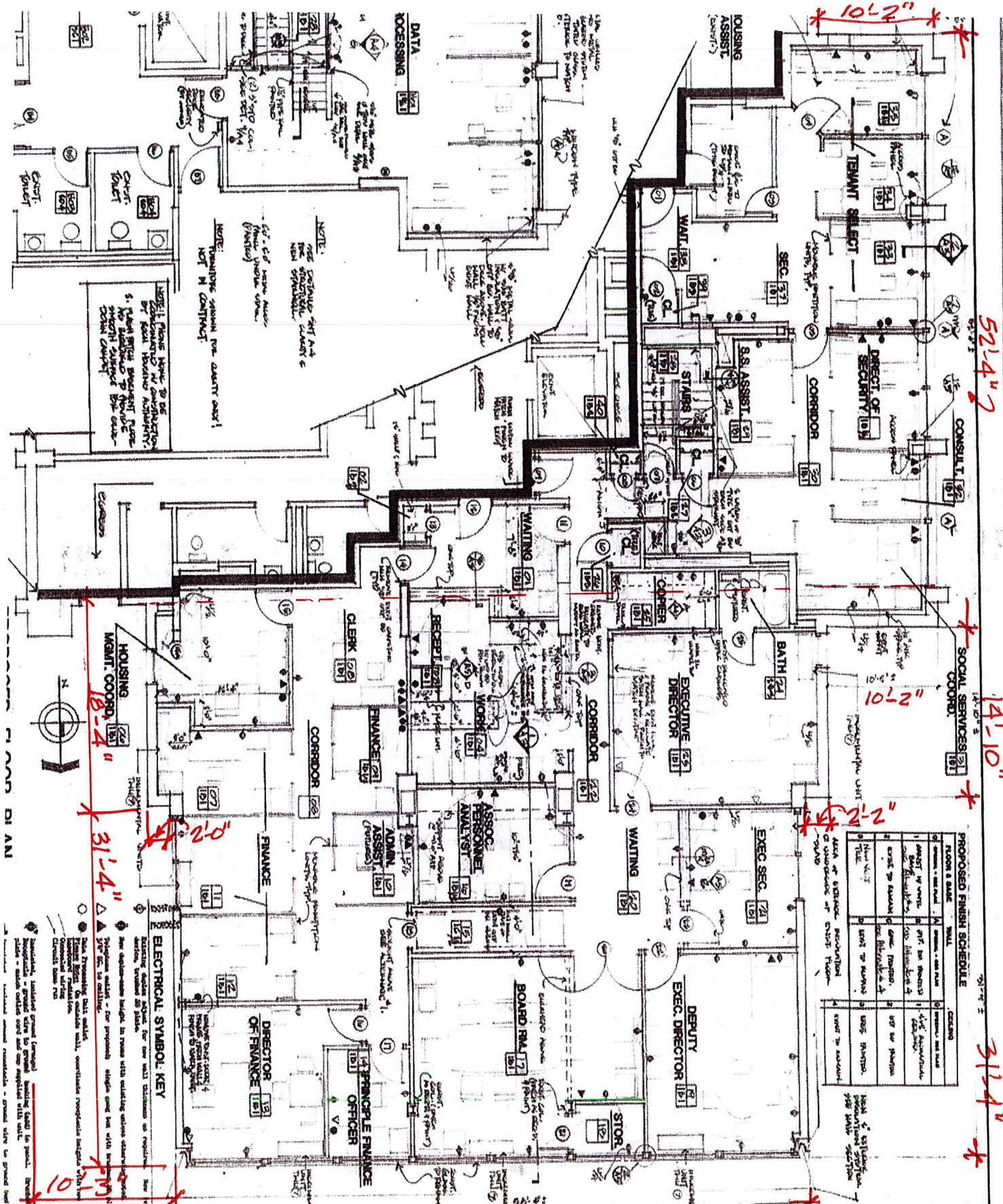

PROPOSED FINISH SCHEDULE

FLOOR & DATE	WALL	CEILING
1st Floor - 10/15/71	Acoustic tile	Acoustic tile
2nd Floor - 10/15/71	Acoustic tile	Acoustic tile
3rd Floor - 10/15/71	Acoustic tile	Acoustic tile
4th Floor - 10/15/71	Acoustic tile	Acoustic tile
5th Floor - 10/15/71	Acoustic tile	Acoustic tile
6th Floor - 10/15/71	Acoustic tile	Acoustic tile
7th Floor - 10/15/71	Acoustic tile	Acoustic tile
8th Floor - 10/15/71	Acoustic tile	Acoustic tile
9th Floor - 10/15/71	Acoustic tile	Acoustic tile
10th Floor - 10/15/71	Acoustic tile	Acoustic tile
11th Floor - 10/15/71	Acoustic tile	Acoustic tile
12th Floor - 10/15/71	Acoustic tile	Acoustic tile
13th Floor - 10/15/71	Acoustic tile	Acoustic tile
14th Floor - 10/15/71	Acoustic tile	Acoustic tile
15th Floor - 10/15/71	Acoustic tile	Acoustic tile
16th Floor - 10/15/71	Acoustic tile	Acoustic tile
17th Floor - 10/15/71	Acoustic tile	Acoustic tile
18th Floor - 10/15/71	Acoustic tile	Acoustic tile
19th Floor - 10/15/71	Acoustic tile	Acoustic tile
20th Floor - 10/15/71	Acoustic tile	Acoustic tile

ELECTRICAL SYMBOL KEY

- Standard electrical symbols for lighting, outlets, switches, etc.
- △ Symbol for a specific electrical component.
- Symbol for another electrical component.
- with a dot: Data processing data outlet.
- with a cross: Data processing data outlet.
- with a triangle: Data processing data outlet.
- with a square: Data processing data outlet.
- with a circle: Data processing data outlet.
- with a diamond: Data processing data outlet.
- with a hexagon: Data processing data outlet.
- with an octagon: Data processing data outlet.
- with a decagon: Data processing data outlet.
- with a dodecagon: Data processing data outlet.
- with a hexagram: Data processing data outlet.
- with a heptagon: Data processing data outlet.
- with an octagram: Data processing data outlet.
- with a nonagon: Data processing data outlet.
- with a decagram: Data processing data outlet.
- with an undecagon: Data processing data outlet.
- with a duodecagon: Data processing data outlet.

(140)
DTE

58'4" ADDITION

10'-2" (top right)

52'-4" (right edge)

14'-10" (right edge)

2'-0" (interior)

4'-2" (interior)

31'-4" (interior)

18'-4" (interior)

31'-4" (interior)

10' (bottom left)

NOTE: ALL DIMENSIONS ARE +/-

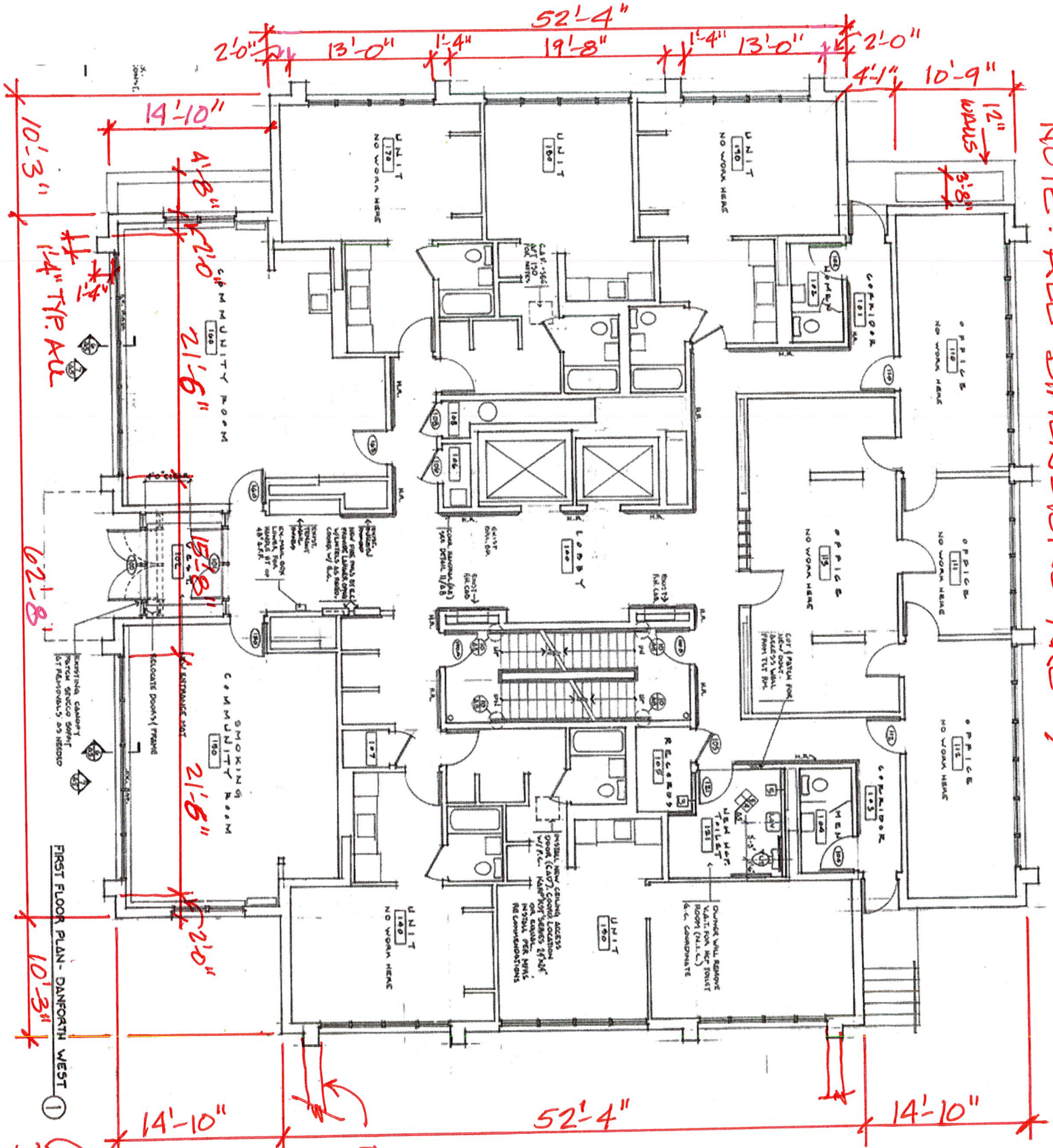

FIRST FLOOR PLAN - DANFORTH WEST

(160) DTW

RETAINING WALL (TYP)

GENERAL REQUIREMENTS FOR: Danforth Towers Façade Repairs

LOCATION: 140 and 160 West Ave, Rochester NY

THE FOLLOWING REQUIREMENTS ARE TO BE CONSIDERED AS PART OF THIS SPECIFICATION:

1. The contractor shall use only material, equipment, and procedures approved by O.S.H.A. All products utilized must be free of known hazardous compounds; any products manufactured outside of the U.S. shall include documentation to verify the products meet all applicable U.S. manufacturing regulations.
2. It is the responsibility of the contractor to make exact measurements and to determine the amount of material and/or dimension of materials needed.
3. The work area shall be picked up and/or swept each day at completion of the days work. All debris is to be disposed of off site by the contractor. If the extent of the work is such that a dumpster is required, the contractor shall supply a dumpster at his/her expense. In no instance is the Authority's dumpster to be used.
4. RHA, as being publicly funded is tax exempt, Contractors shall not factor in their bid price the cost of sales tax for material or expect reimbursement for sales tax. The Contractor awarded the work may call the state offices in Albany, 1-518-485-2889 (Sales Tax Registration Option) for a tax-exempt number for this work. Forms may be obtained via the internet at <http://www.tax.ny.gov/>
5. No substitutions of materials or methods are permitted without the written consent of the Authority.
6. The contractor is responsible to repair at his/her expense any damage to Authority property, its tenants or adjoining property if caused by the contractor's workers or equipment.
7. To minimize disruption to the tenants, all work shall be conducted between the hours of 8:30 A.M. to 4:30 P.M. Monday thru Friday ONLY.
8. Tradesman under direct supervision provided by the contractor shall perform all work.
9. All certificates of Guarantee or Warranty must be supplied to RHA PRIOR to final payment.
10. **The contractor shall be responsible to obtain and provide the Authority all applicable permits - (Building, Plumbing, Electrical, etc...), Certificates of Occupancy if asked for, and N.Y.S. Underwriter's Inspection Certificate.**
11. Contractors must provide valid Certificate of Insurance for General liability, Automotive liability, and Workmen's compensation for minimum coverage amounts as determined by RHA for the entire term of the contract.
12. IF HUD Determined or Davis-Bacon Wage Rates are required for this contract, weekly payroll information must be provided by the contractor on HUD form WH-347.
13. The contractor shall be responsible for all materials, whether issued by the Authority or purchased by the contractor. The contractor must replace at his/her expense any material lost, stolen or damaged.
14. Effective July 18, 2008, all contracts of at least \$250,000.00 will require certification that all laborers, workers and mechanics working on the site, be certified as having successfully completed the OSHA 10-hour construction safety and health course, S1537-A. This provision is an addition to the existing prevailing wage rate laws, Labor Law §220, section 220-h. Proper certification must be presented to the RHA prior to contract award. The RHA will have the right to terminate for cause any contract in which the contract fails to comply with this requirement or any other OSHA or labor regulation.
15. Questions concerning the specifications or scope of work, including those raised at the walk-thru, must be submitted to RHA in writing eight days prior to bid opening. If questions are not submitted, RHA's understanding of the specifications will be final.
16. Direct all questions regarding these specifications to [**dstier@rochesterhousing.org**](mailto:dstier@rochesterhousing.org)
Direct all questions regarding bid forms, bonding, or RHA and HUD regulations to [**David Stier**](mailto:dstier@rochesterhousing.org)
[**dstier@rochesterhousing.org**](mailto:dstier@rochesterhousing.org)

"General Decision Number: NY20240085 01/05/2024

Superseded General Decision Number: NY20230085

State: New York

Construction Type: Residential

County: Monroe County in New York.

RESIDENTIAL CONSTRUCTION PROJECTS (consisting of single family homes and apartments up to and including 4 stories).

Note: Contracts subject to the Davis-Bacon Act are generally required to pay at least the applicable minimum wage rate required under Executive Order 14026 or Executive Order 13658.

Please note that these Executive Orders apply to covered contracts entered into by the federal government that are subject to the Davis-Bacon Act itself, but do not apply to contracts subject only to the Davis-Bacon Related Acts, including those set forth at 29 CFR 5.1(a)(1).

If the contract is entered into on or after January 30, 2022, or the contract is renewed or extended (e.g., an option is exercised) on or after January 30, 2022: Executive Order 14026 generally applies to the contract. The contractor must pay all covered workers at least \$17.20 per hour (or the applicable wage rate listed on this wage determination, if it is higher) for all hours spent performing on the contract in 2024.

If the contract was awarded on or between January 1, 2015 and January 29, 2022, and the contract is not renewed or extended on or after January 30, 2022: Executive Order 13658 generally applies to the contract. The contractor must pay all covered workers at least \$12.90 per hour (or the applicable wage rate listed on this wage determination, if it is higher) for all hours spent performing on that contract in 2024.

The applicable Executive Order minimum wage rate will be adjusted annually. If this contract is covered by one of the Executive Orders and a classification considered necessary for performance of work on the contract does not appear on this wage determination, the contractor must still submit a

conformance request.

Additional information on contractor requirements and worker protections under the Executive Orders is available at <http://www.dol.gov/whd/govcontracts>.

Modification Number Publication Date
0 01/05/2024

BRNY0003-001 07/01/2022

Rates Fringes

BRICKLAYER.....\$ 31.54 15.02

CARP0276-020 07/01/2019

Rates Fringes

CARPENTER

Excludes Form Work,
Drywall Hanging, and Metal

Stud Installation.....\$ 29.75 21.69

Form Work Only.....\$ 29.75 21.69

IRON0033-019 07/01/2023

Rates Fringes

IRONWORKER, STRUCTURAL.....\$ 32.00 31.02

IRON0417-004 07/01/2023

Rates Fringes

IRONWORKER, ORNAMENTAL.....\$ 42.38 50.95+a

a) Paid Holidays: New Year's Day, Memorial Day, Fourth of July, Labor Day, Thanksgiving Day, Day after Thanksgiving (unpaid), Christmas Day.

LABO0210-002 07/01/2016

Rates Fringes

LABORER (Mason Tender -
Cement/Concrete).....\$ 26.38 23.65

SUNY2013-012 03/17/2015

Rates Fringes

CARPENTER (Drywall Hanging and Metal Stud Installation Only).....	\$ 16.91 **	5.56
CEMENT MASON/CONCRETE FINISHER...	\$ 24.58	7.50
ELECTRICIAN.....	\$ 20.86	6.96
IRONWORKER, REINFORCING.....	\$ 27.06	23.02
LABORER: Asbestos Abatement (Removal from Floors, Walls, & Ceilings).....	\$ 18.53	10.88
LABORER: Common or General.....	\$ 16.38 **	0.00
LABORER: Mason Tender - Brick...	\$ 18.03	0.00
OPERATOR: Backhoe/Excavator/Trackhoe.....	\$ 27.88	19.75
OPERATOR: Bulldozer.....	\$ 21.20	0.00
OPERATOR: Loader.....	\$ 27.88	21.40
PAINTER (Brush and Roller).....	\$ 22.15	15.62
PLUMBER.....	\$ 22.36	11.20
ROOFER.....	\$ 18.17	0.00
SHEET METAL WORKER, Includes HVAC Duct Installation.....	\$ 21.39	8.25

WELDERS - Receive rate prescribed for craft performing operation to which welding is incidental.

=====

** Workers in this classification may be entitled to a higher minimum wage under Executive Order 14026 (\$17.20) or 13658 (\$12.90). Please see the Note at the top of the wage determination for more information. Please also note that the minimum wage requirements of Executive Order 14026 are not currently being enforced as to any contract or subcontract to which the states of Texas, Louisiana, or Mississippi, including their agencies, are a party.

Note: Executive Order (EO) 13706, Establishing Paid Sick Leave for Federal Contractors applies to all contracts subject to the Davis-Bacon Act for which the contract is awarded (and any solicitation was issued) on or after January 1, 2017. If this contract is covered by the EO, the contractor must provide

employees with 1 hour of paid sick leave for every 30 hours they work, up to 56 hours of paid sick leave each year. Employees must be permitted to use paid sick leave for their own illness, injury or other health-related needs, including preventive care; to assist a family member (or person who is like family to the employee) who is ill, injured, or has other health-related needs, including preventive care; or for reasons resulting from, or to assist a family member (or person who is like family to the employee) who is a victim of, domestic violence, sexual assault, or stalking. Additional information on contractor requirements and worker protections under the EO is available at <https://www.dol.gov/agencies/whd/government-contracts>.

Unlisted classifications needed for work not included within the scope of the classifications listed may be added after award only as provided in the labor standards contract clauses (29CFR 5.5 (a) (1) (iii)).

The body of each wage determination lists the classification and wage rates that have been found to be prevailing for the cited type(s) of construction in the area covered by the wage determination. The classifications are listed in alphabetical order of ""identifiers"" that indicate whether the particular rate is a union rate (current union negotiated rate for local), a survey rate (weighted average rate) or a union average rate (weighted union average rate).

Union Rate Identifiers

A four letter classification abbreviation identifier enclosed in dotted lines beginning with characters other than ""SU"" or ""UAVG"" denotes that the union classification and rate were prevailing for that classification in the survey. Example: PLUM0198-005 07/01/2014. PLUM is an abbreviation identifier of the union which prevailed in the survey for this classification, which in this example would be Plumbers. 0198 indicates the local union number or district council number where applicable, i.e., Plumbers Local 0198. The next number, 005 in the example, is an internal number used in processing the wage determination. 07/01/2014 is the effective date of the most current negotiated rate, which in this example is July 1, 2014.

Union prevailing wage rates are updated to reflect all rate changes in the collective bargaining agreement (CBA) governing this classification and rate.

Survey Rate Identifiers

Classifications listed under the ""SU"" identifier indicate that no one rate prevailed for this classification in the survey and the published rate is derived by computing a weighted average rate based on all the rates reported in the survey for that classification. As this weighted average rate includes all rates reported in the survey, it may include both union and non-union rates. Example: SULA2012-007 5/13/2014. SU indicates the rates are survey rates based on a weighted average calculation of rates and are not majority rates. LA indicates the State of Louisiana. 2012 is the year of survey on which these classifications and rates are based. The next number, 007 in the example, is an internal number used in producing the wage determination. 5/13/2014 indicates the survey completion date for the classifications and rates under that identifier.

Survey wage rates are not updated and remain in effect until a new survey is conducted.

Union Average Rate Identifiers

Classification(s) listed under the UAVG identifier indicate that no single majority rate prevailed for those classifications; however, 100% of the data reported for the classifications was union data. EXAMPLE: UAVG-OH-0010 08/29/2014. UAVG indicates that the rate is a weighted union average rate. OH indicates the state. The next number, 0010 in the example, is an internal number used in producing the wage determination. 08/29/2014 indicates the survey completion date for the classifications and rates under that identifier.

A UAVG rate will be updated once a year, usually in January of each year, to reflect a weighted average of the current negotiated/CBA rate of the union locals from which the rate is based.

WAGE DETERMINATION APPEALS PROCESS

1.) Has there been an initial decision in the matter? This can be:

- * an existing published wage determination
- * a survey underlying a wage determination
- * a Wage and Hour Division letter setting forth a position on a wage determination matter
- * a conformance (additional classification and rate) ruling

On survey related matters, initial contact, including requests for summaries of surveys, should be with the Wage and Hour National Office because National Office has responsibility for the Davis-Bacon survey program. If the response from this

initial contact is not satisfactory, then the process described in 2.) and 3.) should be followed.

With regard to any other matter not yet ripe for the formal process described here, initial contact should be with the Branch of Construction Wage Determinations. Write to:

Branch of Construction Wage Determinations
Wage and Hour Division
U.S. Department of Labor
200 Constitution Avenue, N.W.
Washington, DC 20210

2.) If the answer to the question in 1.) is yes, then an interested party (those affected by the action) can request review and reconsideration from the Wage and Hour Administrator (See 29 CFR Part 1.8 and 29 CFR Part 7). Write to:

Wage and Hour Administrator
U.S. Department of Labor
200 Constitution Avenue, N.W.
Washington, DC 20210

The request should be accompanied by a full statement of the interested party's position and by any information (wage payment data, project description, area practice material, etc.) that the requestor considers relevant to the issue.

3.) If the decision of the Administrator is not favorable, an interested party may appeal directly to the Administrative Review Board (formerly the Wage Appeals Board). Write to:

Administrative Review Board
U.S. Department of Labor
200 Constitution Avenue, N.W.
Washington, DC 20210

4.) All decisions by the Administrative Review Board are final.

=====

END OF GENERAL DECISION"